

WATTCOTM

Manufacturer of Electric Heating Elements and Controls

TUBULAR HEATERS

immersion heaters

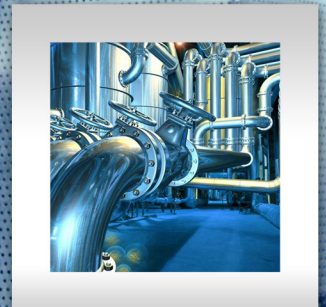
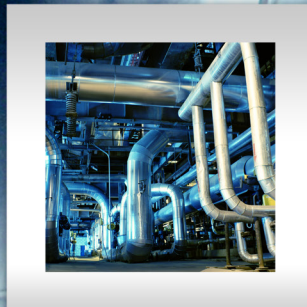
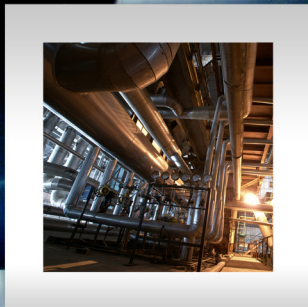

(1-800-492-8826)

www.wattco.com

TUBULAR HEATERS

immersion heaters

OVERVIEW

WATTCO™ tubular elements are the most versatile and best suited solutions to a large number of applications. This is why they are found in major modern heating applications and are known for their superior qualities. Tubular elements can be:

- » Clamped
- » Immersed
- » Cast into metal
- » Easily removable

Surface tubular elements are used for surface heating and are sold separately or made into process heating assemblies including:

- » Flange heaters
- » Screwplug heaters
- » Circulation heaters, vessels
- » Strip elements
- » Over-the-side heaters
- » Cartridge heaters
- » Duct heaters
- » Band heaters
- » Infrared heaters



KEY FEATURES

- » Standard diameters: 0.260", 0.315", 0.375", 0.430", 0.475" and 0.625"
- » Available in a broad variety of sheaths, diameters and ratings
- » Supplied with electrically isolated sheath
- » Provide superior internal electrical insulation and heat

BENEFITS

- » Easy to install
- » Configurable to virtually any shape
- » Compact
- » Precise and easy control of heat output
- » Durable
- » Easy to maintain

FACTORS

Please consider the following factors to select the ideal WATTCO™ tubular heater for your application:

- » Heating element watt density
- » Sheath material (corrosive or non corrosive)
 - Temperature of the corrodent
 - Degree of aeration of the corrodent
 - Velocity of the corrodent
 - Ambient temperature

SELECTING

WATTCO™ TUBULAR HEATER

Depending on their rating, sheath and shape, WATTCO™ tubular elements are used in a variety of heat applications (conduction, convection, radiation heating) that require process temperatures of up to 750°C (1 382°F) to heat liquids, gases and solids.



CLOSE UP



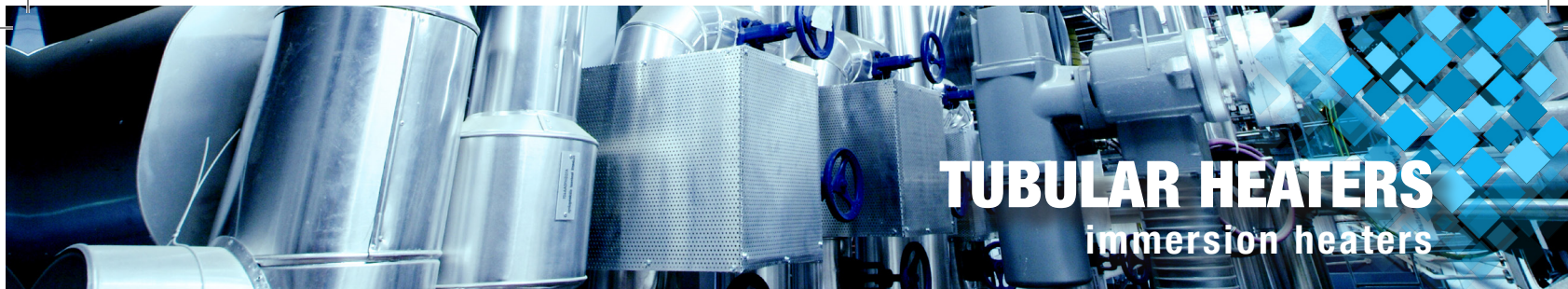

TUBULAR HEATERS

immersion heaters

APPLICATIONS	SHEATH MATERIAL
Water Water solutions non-corrosive to copper	Copper
Oil Grease Alkaline cleaning solutions Tars Asphalt	Steel
Corrosive liquids Food processing equipment	Stainless steel
Air heating Radiant heating Cleaning and degreasing solutions Plating and pickling solutions Corrosive liquids	Incoloy®, Inconel®
Acid Corrosive liquids	Titanium

Incoloy® and Inconel® are registered trademarks of Inco Alloys International

CONSTRUCTION

TUBULAR ELEMENTS – FEATURES AND COMPONENTS

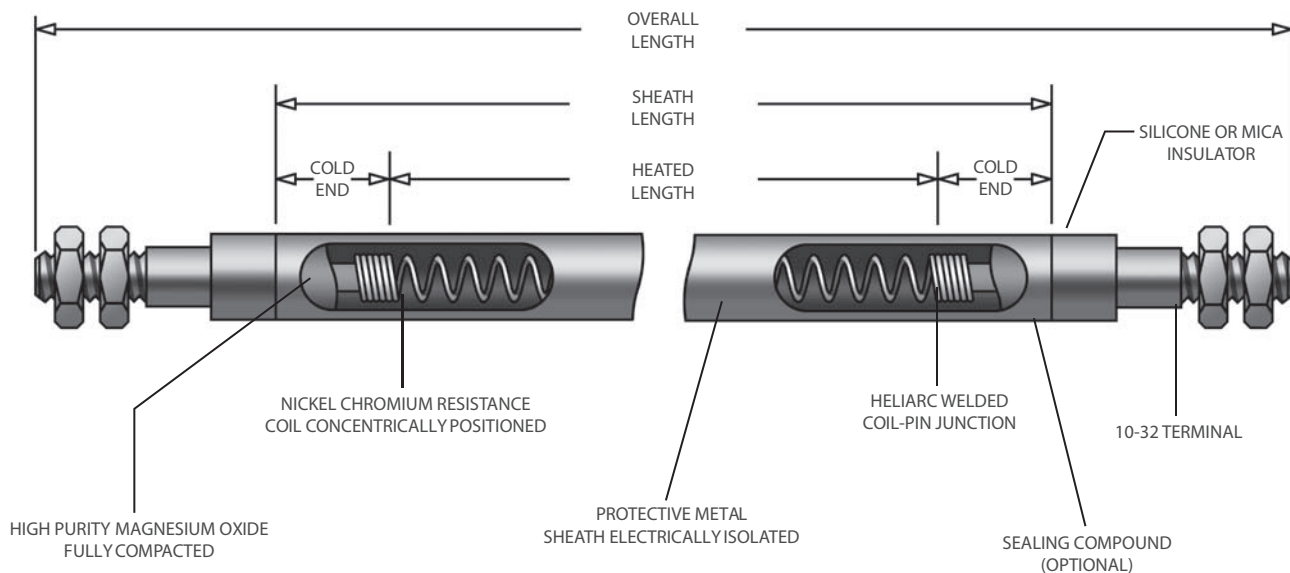

TUBULAR HEATERS

immersion heaters

FIG. A

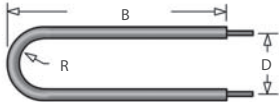

FIG. B

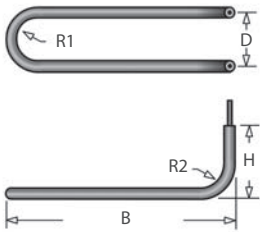

FIG. C

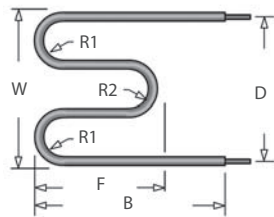

FIG. D

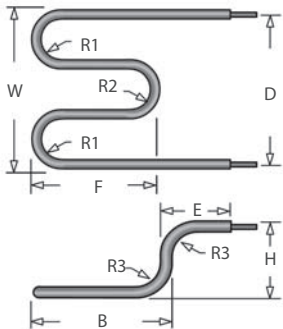
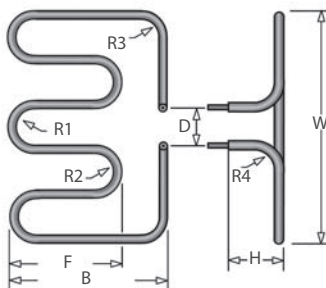

FIG. E



STANDARD SHAPES BENDING

WATTCO™ tubular heaters are factory-configured to almost any shape or size. Custom bending diameters can be made upon request.

Figures A to K show some of the most popular element shapes. Select the shape that meets your requirements and refer to it when ordering or requesting prices.

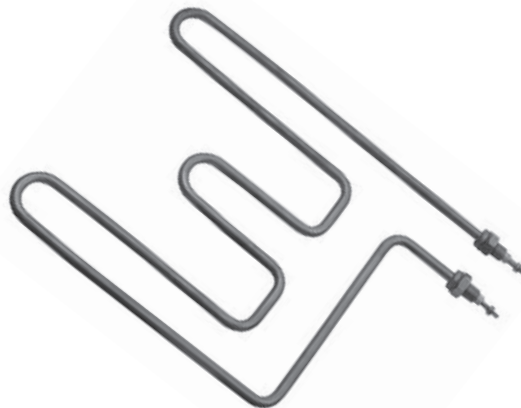

FIG. F

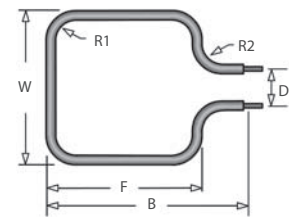

FIG. G

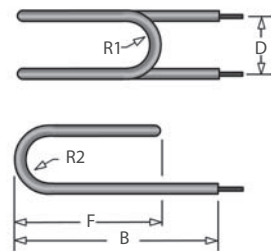

FIG. H

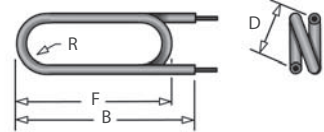

FIG. I

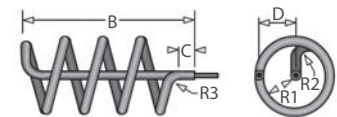

FIG. J

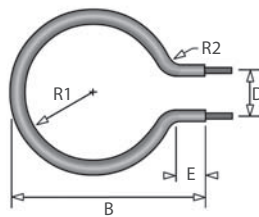
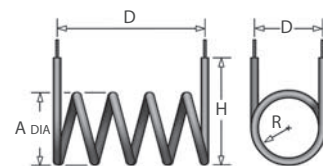

FIG. K



TUBULAR HEATERS

immersion heaters

STANDARD INSTALLATIONS

Figures L to W show some of the most popular type of installations. Select the installation that meets your needs and make reference to it before placing an order or requesting prices.

KEY FEATURES

- » Unlimited number of custom bends available.
- » Magnesium Oxide insulating properties.
- » Great flexibility to meet application needs.
- » Watt Densities of up to 120 WPSI available.
- » Thicker sheath wall are available for intensive applications.
- » Silicone seals to ensure moisture resistance in humid environments.
- » Custom made cold sections are available.

BENEFITS

- » Sheath temperatures of up to 1200°F.
- » Numerous types of terminations available.

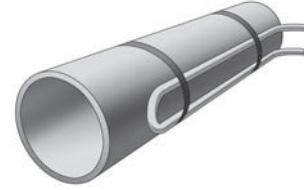

FIG. R - Clamped to walls, hoppers, and pipes



FIG. S - To be inserted in drilled holes, plates or cylinders



FIG. T - In between plates

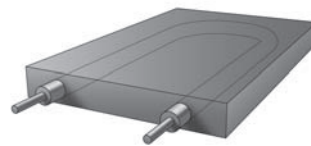

FIG. U - Cast-in iron, aluminum, or copper

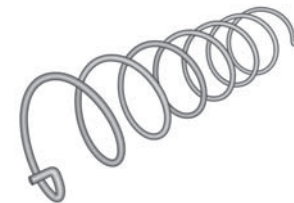

FIG. V - Bent to fit system shape



FIG. L - Ovens or cabinets

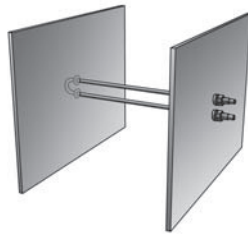

FIG. O - High wattage resistors or load banks



FIG. M - Ducts



FIG. P - Radiating heat

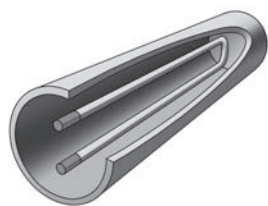

FIG. N - Pipe wells



FIG. Q - To be immersed in liquids



FIG. W - Finned heater assemblies

TUBULAR HEATERS

immersion heaters

TABLE 1
Terminal Type Specification

TERM. TYPE	DIM. 'W'	THD. SIZE	MAX. VOLTS	MAX. TEMPS	SUITABLE FOR ELEMENT DIAMETERS (in.)				
					0.260	0.315	0.375	0.430	0.475
A	1 1/8"	#10-32*	600	400°C	✓	✓	✓	✓	✓
B	1 1/8"	#10-32*	600	200°C	✓	✓	✓	✓	✓
C	1 1/8"	#10-32*	600	150°C	✓	✓	✓	✓	✓
D	1 1/8"	#10-32*	600	400°C	✓	✓	✓	✓	✓
E	1 1/8"	#10-32*	600	400°C	—	—	—	✓	—
F	13/16"	#10-32*	250	400°C	✓	✓	✓	✓	✓
G	13/16"	#10-32*	250	200°C	✓	✓	✓	✓	✓
H	13/16"	#10-32*	250	400°C	✓	✓	✓	✓	✓
I	11/16"	#10-32*	250	400°C	✓	✓	✓	✓	✓
J	11/16"	#10-32*	250	200°C	✓	✓	✓	✓	✓
K	11/16"	#10-32*	250	400°C	✓	✓	✓	✓	✓
L	15/16"	N/A	250	250°C	✓	✓	✓	✓	✓
M	15/16"	N/A	250	200°C	✓	✓	✓	✓	✓
N	15/16"	N/A	250	250°C	✓	✓	✓	✓	✓
O	1 1/8"	#8-32	250	400°C	✓	—	—	—	—
O	1 3/8"	#10-32	250	400°C	—	✓	—	—	—
O	1 3/8"	#10-32	250	400°C	—	—	✓	—	—
O	1 5/8"	1/4"-28	250	400°C	—	—	—	✓	—
P	1	N/A	300	200°C	✓	✓	✓	✓	✓
Q	1/2"	N/A	300	200°C	✓	✓	✓	✓	✓
R*	1 5/8"	N/A	300	90°C	✓	✓	✓	✓	—

* 1 1/8" available as 1"; #10-32 available in #8-32; type R, W = 2 1/4" for 0.375 and 2 3/4" for 0.430

STANDARD TERMINAL TYPES

The following section shows the most common terminal types. Select the terminal type that meets your application and make reference to it before placing an order or requesting prices.

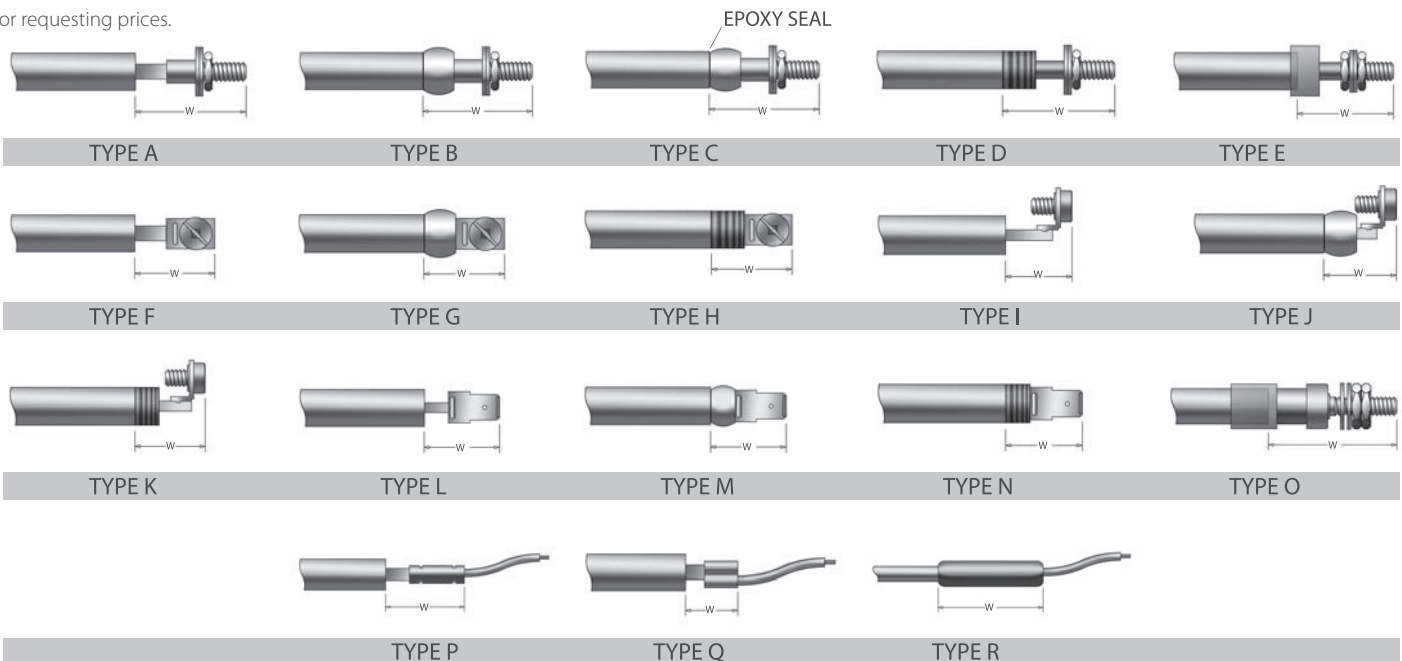

NOTE: THE APPROPRIATE CURRENT OF EACH TERMINAL TYPE PARTLY DEPENDS ON THE APPLICATION. CALL US FOR DETAILS AT 1.800.492.8826

TUBULAR HEATERS

immersion heaters

TABLE 1
Incoloy® Sheathed Elements - 0.315" (8.0 mm) Diameter

HEATED LENGTH		WATTAGE	VOLTAGE	DENSITY		AMP			RESISTANCE	CATALOG NUMBER
in.	mm			W/in. ²	W/cm ²	120	208	240		
20	508	500	120, 208, 240	25	3.9	4.2	2.4	2.1	28.8	WT064531
22	559	500	120, 208, 240	23	3.6	4.2	2.4	2.1	28.8	WT064532
24	610	600	120, 208, 240	25	3.9	5.0	2.9	2.5	24.0	WT064533
26	660	700	120, 208, 240	27	4.2	5.8	3.4	2.9	20.6	WT064534
28	711	700	120, 208, 240	25	3.9	5.8	3.4	2.9	20.6	WT064535
30	762	800	120, 208, 240	27	4.2	6.7	3.8	3.3	18.0	WT064536
32	813	800	120, 208, 240	25	3.9	6.7	3.8	3.3	18.0	WT064537
34	864	800	120, 208, 240	24	3.7	6.7	3.8	3.3	18.0	WT064538
36	914	800	120, 208, 240	22	3.5	6.7	3.8	3.3	18.0	WT064539
38	965	900	120, 208, 240	24	3.7	7.5	4.3	3.8	16.0	WT064540
40	1016	1000	120, 208, 240	25	3.9	8.3	4.8	4.2	14.4	WT064541
44	1118	1100	120, 208, 240	25	3.9	9.2	5.3	4.6	13.1	WT064542
48	1219	1200	120, 208, 240	25	3.9	10.0	5.8	5.0	12.0	WT064543
52	1321	1300	120, 208, 240	25	3.9	10.8	6.3	5.4	11.1	WT064544
54	1372	1400	120, 208, 240	26	4.1	11.7	6.7	5.8	10.3	WT064555
56	1422	1500	120, 208, 240	27	4.2	12.5	7.2	6.3	9.6	WT064556
60	1524	1500	120, 208, 240	25	3.9	12.5	7.2	6.3	9.6	WT064557
62	1575	1600	120, 208, 240	26	4.0	13.3	7.7	6.7	9.0	WT064558
64	1626	1700	120, 208, 240	27	4.2	14.2	8.2	7.1	8.5	WT064559
66	1676	1800	120, 208, 240	28	4.3	15.0	8.7	7.5	8.0	WT064560
68	1727	1800	120, 208, 240	27	4.1	15.0	8.7	7.5	8.0	WT064561
70	1778	1800	120, 208, 240	26	4.0	15.0	8.7	7.5	8.0	WT064562
72	1829	1900	120, 208, 240	27	4.1	15.8	9.1	7.9	7.6	WT064563
74	1880	1900	120, 208, 240	26	4.0	15.8	9.1	7.9	7.6	WT064564
76	1930	2000	120, 208, 240	27	4.1	16.7	9.6	8.3	7.2	WT064565
78	1981	2000	120, 208, 240	26	4.0	16.7	9.6	8.3	7.2	WT064566
80	2032	2100	120, 208, 240	27	4.1	17.5	10.1	8.8	6.9	WT064567
85	2159	2100	120, 208, 240	25	3.9	17.5	10.1	8.8	6.9	WT064568
90	2286	2200	120, 208, 240	25	3.8	18.3	10.6	9.2	6.5	WT064569
95	2413	2300	120, 208, 240	24	3.8	19.2	11.1	9.6	6.3	WT064570
100	2540	2400	120, 208, 240	24	3.8	20.0	11.5	10.0	6.0	WT064571
105	2667	2500	120, 208, 240	24	3.7	20.8	12.0	10.4	5.8	WT064572
110	2794	2600	120, 208, 240	24	3.7	21.7	12.5	10.8	5.5	WT064573
115	2921	2700	120, 208, 240	24	3.7	22.5	13.0	11.3	5.3	WT064574
120	3048	2800	120, 208, 240	24	3.7	23.3	13.5	11.7	5.1	WT064575
125	3175	2900	120, 208, 240	23	3.6	24.2	13.9	12.1	5.0	WT064576
130	3302	3000	120, 208, 240	23	3.6	25.0	14.4	12.5	4.8	WT064577
135	3429	3100	120, 208, 240	23	3.6	25.8	14.9	12.9	4.6	WT064578
140	3556	3500	120, 208, 240	25	3.9	29.2	16.8	14.6	4.1	WT064579
145	3683	3700	120, 208, 240	26	4.0	30.8	17.8	15.4	3.9	WT064580

* 1 1/8" available as 1"; #10-32 available in #8-32; type R, W = 2 1/4" for 0.375 and 2 3/4" for 0.430

STANDARD INSTALLATIONS

ELEMENTS WITH 0.315" (8.0 MM) AND 0.430" (10.9 MM) DIAMETERS

- » Incoloy® sheathed elements are found in Table 1 and 2.
- » Elements with a 0.315" diameter are used at 240V or less (refer to Table 1).
- » Elements with a 0.430" diameter (or larger) are suitable for a maximum voltage of 600V (refer to Table 2).
- » Manufactured in an extensive range of lengths, wattages voltages, ratings, and heated length combinations (0.260" up to 0.625" diameters).
- » Available in a selection of sheath materials.

For further details, please call us at **1.800.4WATTCO (1.800.492.8826)**

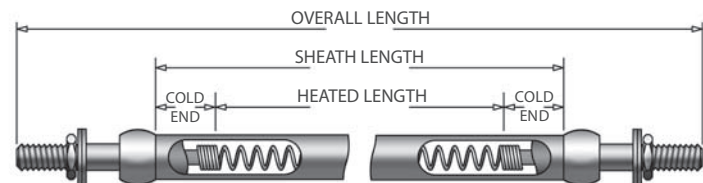

TUBULAR HEATERS

immersion heaters

TABLE 2
Incoloy® Sheathed Elements - 0.430" (10.9 mm) Diameter

HEATED LENGTH		WATTAGE	VOLTAGE	DENSITY		AMP			RESISTANCE	CATALOG NUMBER
in.	mm			W/in. ²	W/cm ²	120	208	240		
20	508	700	120, 208, 240	26	4.0	5.8	3.4	2.9	20.6	WT074531
25	635	900	120, 208, 240	27	4.1	7.5	4.3	3.8	16.0	WT074532
30	762	1000	120, 208, 240	25	3.8	8.3	4.8	4.2	14.4	WT074533
35	889	1200	120, 208, 240	25	3.9	10.0	5.8	5.0	12.0	WT074534
40	1016	1300	120, 208, 240	24	3.7	10.8	6.3	5.4	11.1	WT074535
45	1143	1500	120, 208, 240	25	3.8	12.5	7.2	6.3	9.6	WT074536
50	1270	2000	120, 208, 240	30	4.6	16.7	9.6	8.3	7.2	WT074537
55	1397	2100	120, 208, 240	28	4.4	17.5	10.1	8.8	6.9	WT074538
60	1524	2200	120, 208, 240	27	4.2	18.3	10.6	9.2	6.5	WT074539
65	1651	2300	120, 208, 240	26	4.1	19.2	11.1	9.6	6.3	WT074540
70	1778	2400	120, 208, 240	25	3.9	20.0	11.5	10.0	6.0	WT074541
75	1905	2500	120, 208, 240	25	3.8	20.8	12.0	10.4	5.8	WT074542
80	2032	2600	120, 208, 240	24	3.7	21.7	12.5	10.8	5.5	WT074543
85	2159	2700	120, 208, 240	24	3.7	22.5	13.0	11.3	5.3	WT074544
90	2286	2900	120, 208, 240	24	3.7	24.2	13.9	12.1	5.0	WT074555
95	2413	3200	120, 208, 240	25	3.9	26.7	15.4	13.3	4.5	WT074556
100	2540	3300	120, 208, 240	24	3.8	27.5	15.9	13.8	4.4	WT074557
105	2667	3400	120, 208, 240	24	3.7	28.3	16.3	14.2	4.2	WT074558
110	2794	3500	120, 208, 240	24	3.7	29.2	16.8	14.6	4.1	WT074559
115	2921	3600	120, 208, 240	23	3.6	30.0	17.3	15.0	4.0	WT074560
120	3048	3900	120, 208, 240	24	3.7	32.5	18.8	16.3	3.7	WT074561
125	3175	4200	120, 208, 240	25	3.9	35.0	20.2	17.5	3.4	WT074562
130	3302	4400	120, 208, 240	25	3.9	36.7	21.2	18.3	3.3	WT074563
135	3429	4600	120, 208, 240	25	3.9	38.3	22.1	19.2	3.1	WT074564
140	3556	5000	120, 208, 240	26	4.1	41.7	24.0	20.8	2.9	WT074565
145	3683	5400	120, 208, 240	28	4.3	45.0	26.0	22.5	2.7	WT074566
150	3810	5700	120, 208, 240	28	4.4	47.5	27.4	23.8	2.5	WT074567
155	3937	5900	120, 208, 240	28	4.4	49.2	28.4	24.6	2.4	WT074568
160	4064	6000	120, 208, 240	28	4.3	50.0	28.8	25.0	2.4	WT074569
165	4191	6100	120, 208, 240	27	4.3	50.8	29.3	25.4	2.4	WT074570
170	4318	6200	120, 208, 240	27	4.2	51.7	29.8	25.8	2.3	WT074571
175	4445	6300	120, 208, 240	27	4.1	52.5	30.3	26.3	2.3	WT074572
175	4445	6400	120, 208, 240	27	4.2	53.3	30.8	26.7	2.3	WT074573
180	4572	6500	120, 208, 240	27	4.2	54.2	31.3	27.1	2.2	WT074574
180	4572	6600	120, 208, 240	27	4.2	55.0	31.7	27.5	2.2	WT074575
185	4699	6700	120, 208, 240	27	4.2	55.8	32.2	27.9	2.1	WT074576
190	4826	6800	120, 208, 240	26	4.1	56.7	32.7	28.3	2.1	WT074577
190	4826	6900	120, 208, 240	27	4.2	57.5	33.2	28.8	2.1	WT074578
190	4826	7000	120, 208, 240	27	4.2	58.3	33.7	29.2	2.1	WT074579
190	4826	7100	120, 208, 240	28	4.3	59.2	34.1	29.6	2.0	WT074580

ELEMENTS (continued)

ELEMENTS WITH 0.315" (8.0 MM) AND 0.430" (10.9 MM) DIAMETERS

- » Terminal box can be added upon request.
- » Cold end lengths can be designed to practically any desired length typically between 40 and 150 mm (1.6" - 5.9"). Elements can be shipped in less than 4 working days.
- » Multiple elements are field wired in series or parallel or star & delta to better suit the requirements of your application.
- » Multiple stages are also available.
- » Custom elements can always be available to better meet your specific needs.
- » For quicker deliveries, please consult the factory.
- » Tubular elements can achieve extremely high temperatures and can be dangerous if improperly selected and applied.

If you are unsure of your selection or if you require further assistance, please call us immediately at **1.800.4WATTCO (1.800.492.8826)**

When ordering, please specify the following:

- Quantity
- Catalogue no.
- Voltage
- Wattage
- Cold end length
- Terminal type
- Operating temperature and controls
- Sheath type

TUBULAR HEATERS

immersion heaters

EXTRA FEATURES

THREADED FITTING (FIG. 1)

- » Brazed, crimped or welded to the element's cold section.
- » Used as a tight joint to the heater, which is fixed in open tanks or vessels.
- » Supplied in brass, steel, or stainless steel.

COMPRESSION FITTING (FIG. 2)

- » Available in nickel-plated brass for field installation on elements of 0.375", 0.430", 0.475" elements diameter.

TERMINAL BOX (FIG. 3)

Moisture resistant terminal boxes are:

- » Factory installed

Note:

- » Special requests can be made to have holes predrilled into the terminal boxes. This can provide easier tubular installation on site.
- » Elements can require fittings to connect to the terminal box.

ELEMENT CLAMP (FIG. 4)

- » The two-piece stainless steel clamps shown to the right can serve as element standoffs in ovens or tanks.
- » Use half of the clamp with a stud welded to the tank or plate to suit clamp-on applications.
- » Available "C" dimensions: 1 1/4", 1 7/16", 1 5/8" and 1 15/16".

MOUNTING BRACKETS (FIGS. 5-7)

- » WATTCO™ can crimp standard mounting brackets to elements to help with installation.
- » Special brackets can be configured on to your elements.

PART NUMBERS

When ordering extra features, please provide the following catalogue numbers:

FIG. 1..	DESCRIPTION	CAT. NO.
FIG. 2.....	Compression Fitting	X10347
FIG. 3.....	Terminal Box (small diameter)	X10643
FIG. 3.....	Terminal Box (large diameter)	BX0508
FIG. 4.....	Element Clamp	BX0517
FIG. 5.....	Bracket	CL5975
FIG. 6.....	Bracket	FN4322
FIG. 7.....	Bracket	CL7654

Call us for details at **1.800.4WATTCO (1.800.492.8826)**

FIG. 1

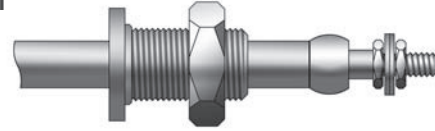

FIG. 2

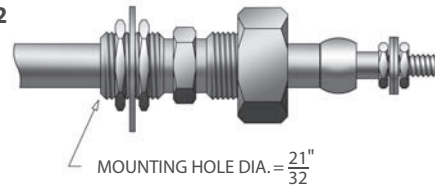

FIG. 3

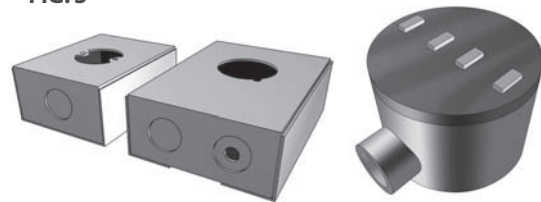

FIG. 4

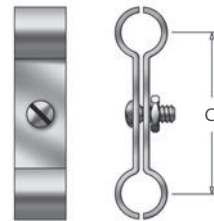

FIG. 5

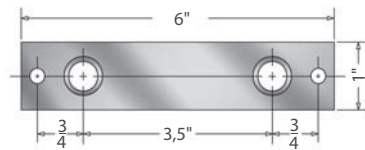

FIG. 6

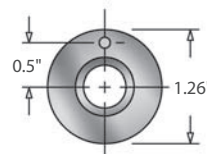
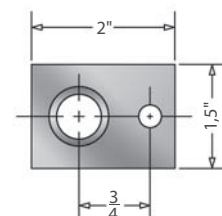
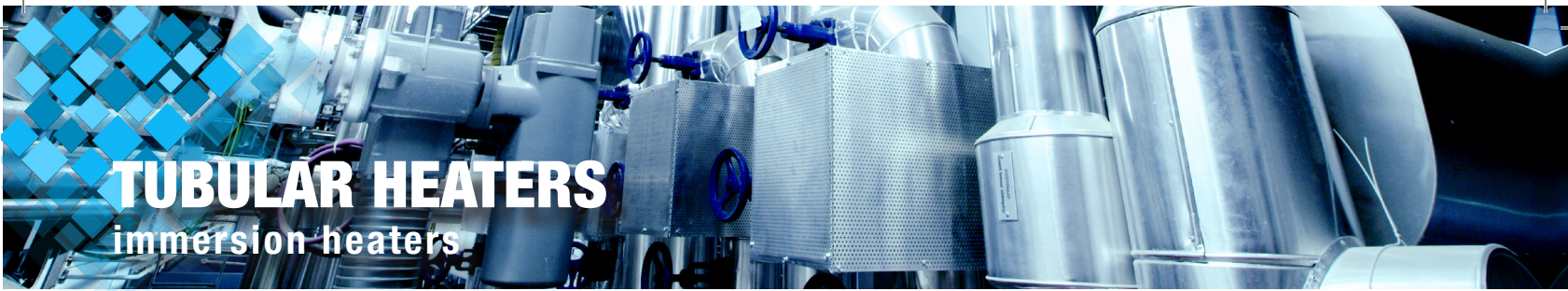

FIG. 7





TUBULAR HEATERS

immersion heaters

OVERVIEW

Versatile, durable, and reliable, WATTCO™ finned tubular heaters are used for forced convection heating or air and gas heating systems. They are customized to meet your specific application needs.



FEATURES

- » Various sizes of diameters
- » Main sheath material: steel or stainless steel
- » Standard fin material: steel or stainless steel



BENEFITS

- » Increase heat transfer surface area
- » Safe to operate (minimal risk of fire or electrical shock)
- » Durable
- » Built solid
- » Easy to maintain

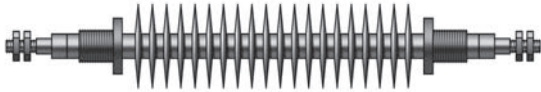

FACTORS

AFFECTING TEMPERATURE

Operating temperatures of finned element change according to the following factors:

- » Air velocity
- » Air temperature
- » Watts per square inch of finned element

FIG. 1 - Watt Density vs. Air Temperature for 797°F (425°C) Fin Temperature

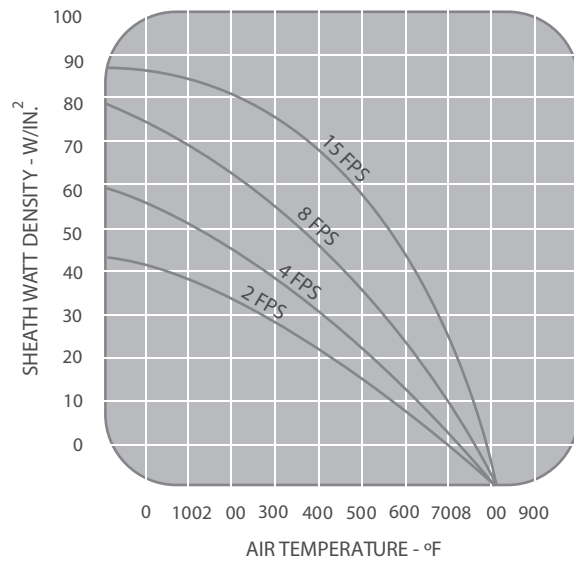

As shown in Figure 1, the combination of these factors results in a sheath temperature of 425°C (797°F).

Note: These factors are approximate as fin efficiency and element spacing may bring about variations in temperature. Please consult factory for further information

APPLICATIONS	SHEATH MATERIAL	FIN MATERIAL
Forced circulation	Steel	Steel or Stainless
Ducts	Steel	Steel or Stainless
Fan forced electric heaters	Steel	Steel or Stainless
Recirculating ovens	Steel	Steel or Stainless
Loading resistors	Steel	Steel or Stainless

COATINGS
Bare steel
Nickel-plated
Aluminum painted
Black enamel

TUBULAR HEATERS

immersion heaters

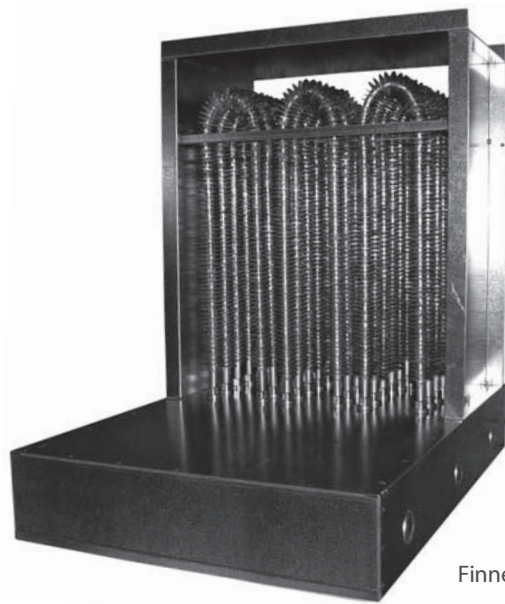

Finned Tubular Heater

SELECTING

WATTCO™ FINNED TUBULAR HEATER

- » Select the proper element by first specifying if the element has a minimum diameter of 0.430" if the power supply voltage is more than 300V.

Depending on your requirements, special terminals can be installed on the 0.315" diameter elements so they can be used up to 600V.

- » Standard fin sizes and pitches supplied by WATTCO™ are listed in Table 1 above. Other sizes are available on special order.

Watt Density = Sheath watt density X Element surface area per lineal inch.

- » Determine the number of heated length of element required for a specific wattage output. You will need more than one element for larger wattage or three-phase installations.

FIG. 2 - Velocity vs. Air Temperature for a Fin Temperature of 800°F (425°C)

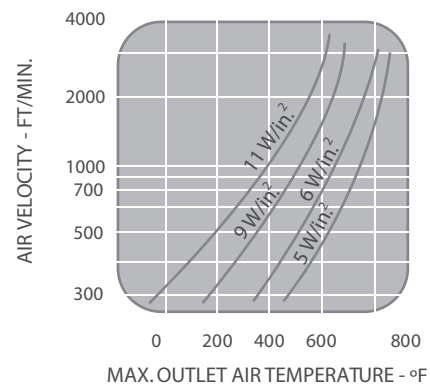
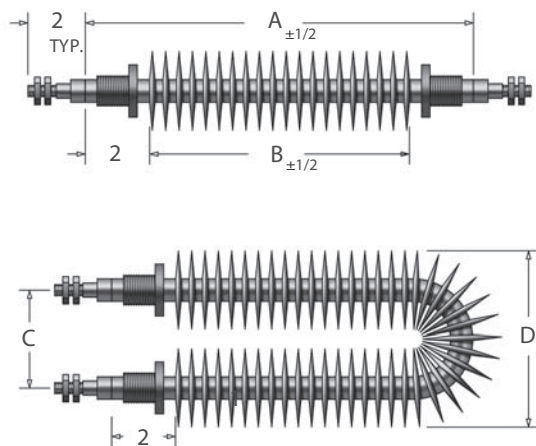

NEED ASSISTANCE?

Please call us at **1.800.4WATTCO (1.800.492.8826)** or send a fax at **514.488.9126** for assistance when selecting your elements, as other factors that are not mentioned above should be taken into consideration.

TUBULAR HEATERS

immersion heaters

TABLE 1
Finned Elements Without Fittings

FIG. 3

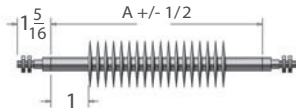

FIG. 4

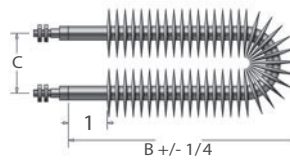
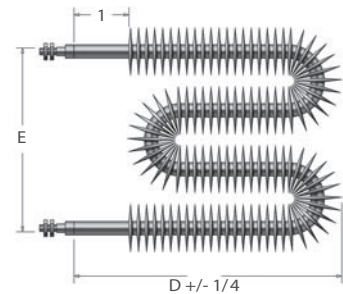

FIG. 5



kW	STANDARD VOLTAGES	DIM. A		CAT. NO FIG. 3	DIM. B		DIM. C		CAT. NO FIG. 4	DIM. D		DIM. E		CAT. NO FIG. 5
		mm	(in.)		mm	(in.)	mm	(in.)		mm	(in.)	mm	(in.)	
.430 DIA. ELEMENT: 1 1/8" O.D. FIN														
2	240,480,600	686	27	WTF585JO	356	14	76	3	WTF585UO	203.2	8	304.8	12	WTF585WO
3	"	1016	40	WTF586JO	508	20	76	3	WTF586UO	279.4	11	304.8	12	WTF586WO
4	"	1321	52	WTF587JO	660	26	76	3	WTF587UO	355.6	14	304.8	12	WTF587WO
5	"	1651	65	WTF588JO	813	32	76	3	WTF588UO	431.8	17	304.8	12	WTF588WO
6	"	1930	76	WTF589JO	965	38	76	3	WTF589UO	508	20	304.8	12	WTF589WO
7	"	2261	89	WTF590JO	1143	45	76	3	WTF590UO	584.2	23	304.8	12	WTF590WO
8	"	2591	102	WTF591JO	1270	50	76	3	WTF591UO	685.8	27	304.8	12	WTF591WO

FIG. 3

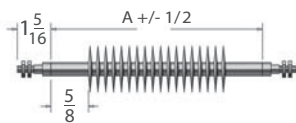

FIG. 4

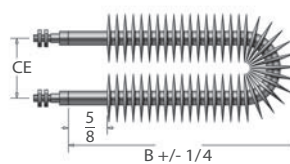
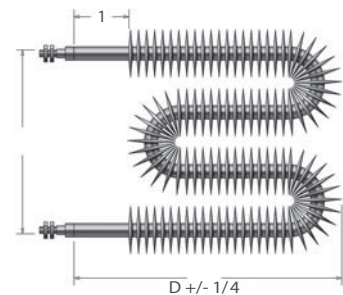

FIG. 5



kW	STANDARD VOLTAGES	DIM. A		CAT. NO FIG. 3	DIM. B		DIM. C		CAT. NO FIG. 4	DIM. D		DIM. E		CAT. NO FIG. 5
		mm	(in.)		mm	(in.)	mm	(in.)		mm	(in.)	mm	(in.)	
.315 DIA. ELEMENT: 1" O.D. FIN														
2	240, 480, 600	482.6	19	WTF285JO	228.6	9	76.2	3	WTF285UO	152.4	6	304.8	12	WTF285WO
3	"	863.6	34	WTF286JO	355.6	14	76.2	3	WTF286UO	254	10	304.8	12	WTF286WO
4	"	1244.6	49	WTF287JO	482.6	19	76.2	3	WTF287UO	355.6	14	304.8	12	WTF287WO
5	"	1625.6	64	WTF288JO	609.6	24	76.2	3	WTF288UO	457.2	18	304.8	12	WTF288WO
6	"	1981.2	78	WTF289JO	736.6	29	76.2	3	WTF289UO	558.8	22	304.8	12	WTF289WO
7	"	2387.6	94	WTF290JO	863.6	34	76.2	3	WTF290UO	660.4	26	304.8	12	WTF290WO

EXTRA FEATURES: Refer to **pages 6 and 9**

WHEN ORDERING, PLEASE SPECIFY: Quantity, catalogue no., voltage, wattage, and extra features required.

WATT DENSITY

Typical WATTCO™ finned heaters have up to 30 watts/in of total heated surface area. If you require higher heat output, please consult with our sales department.

MOUNTING

The following heaters can be fixed with brazed, crimped, or welded plates (refer to **Figures 5 to 7** on **page 9**). Refer to **page 6** to find out about standard elements with factory-fixed fittings for installation.

FACTORS TO CONSIDER WHEN SELECTING A SAFE WATTAGE RATING

- » Air velocity over heater
- » Outlet air temperature
- » Allowable sheath temperatures

See **Figure 2** on **page 11** to find out about the required air velocity to prevent overheating.

TUBULAR HEATERS

immersion heaters

TABLE 2
Finned Elements With Fittings

FIG. 6

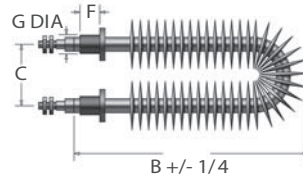
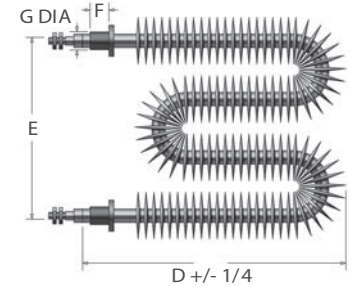

FIG. 7



kW	STANDARD VOLTAGES	DIM. F		DIM. G		DIM. B		CAT. NO FIG. 6	DIM. D		DIM. E		CAT. NO FIG. 7
		mm	(in.)	mm	(in.)	mm	(in.)		mm	(in.)	mm	(in.)	
.430 DIA. ELEMENT: 1^{1/8}" O.D. FIN													
2	240,480,600	32	1.25	16	0.63	635	25	WTF585UF	330.2	13	304.8	12	WTF585WF
3	"	32	1.25	16	0.63	939.8	37	WTF586UF	457.2	18	304.8	12	WTF586WF
4	"	32	1.25	16	0.63	1143	45	WTF587UF	609.6	24	304.8	12	WTF587WF
5	"	32	1.25	16	0.63	1397	55	WTF588UF	762	30	304.8	12	WTF588WF
6	"	32	1.25	16	0.63	1727.2	68	WTF589UF	863.6	34	304.8	12	WTF589WF
7	"	32	1.25	16	0.63	1981.2	78	WTF590UF	1016	40	304.8	12	WTF590WF
8	"	32	1.25	16	0.63	2413	95	WTF591UF	1219.2	48	304.8	12	WTF591WF

FIG. 6

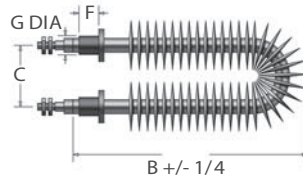
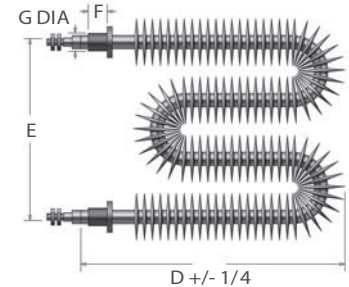

FIG. 7



kW	STANDARD VOLTAGES	DIM. F		DIM. G		DIM. B		CAT. NO FIG. 6	DIM. D		DIM. E		CAT. NO FIG. 7
		mm	(in.)	mm	(in.)	mm	(in.)		mm	(in.)	mm	(in.)	
.315 DIA. ELEMENT: 1" O.D. FIN													
2	240,480,600	32	1.25	13	0.52	635	25	WTF285UF	457.2	18	304.8	12	WTF285WF
3	"	32	1.25	13	0.52	939.8	37	WTF286UF	660.4	26	304.8	12	WTF286WF
4	"	32	1.25	13	0.52	1168.4	46	WTF287UF	863.6	34	304.8	12	WTF287WF
5	"	32	1.25	13	0.52	1447.8	57	WTF288UF	1016	40	304.8	12	WTF288WF
6	"	32	1.25	13	0.52	1727.2	68	WTF289UF	1219.2	48	304.8	12	WTF289WF
7	"	32	1.25	13	0.52	1981.2	78	WTF290UF	1422.4	56	304.8	12	WTF290WF

EXTRA FEATURES: Refer to **pages 6 and 9**

WHEN ORDERING, PLEASE SPECIFY: Quantity, catalogue no., voltage, wattage, and extra features required.

SPECIAL WATTAGE

A special watt density (watts/in of heated surface area) may be necessary for the following cases:

- » Low air velocities
- » High outlet air temperatures

WATTCO™ heaters are available in lower wattage ratings (i.e., an air velocity of 800 ft./min. and an outlet air temperature of 500°F).

In **Figure 2** on **page 11**, it can be seen that 6 watts/in would be the maximum recommended watt density. As standard heaters are 10 watts/in, special elements with 6/10 or 60% of the kW ratings are required (refer to Tables 1 or 2).