

WATTCO™

Manufacturer of Electric Heating Elements and Controls

DUCT HEATERS air heaters

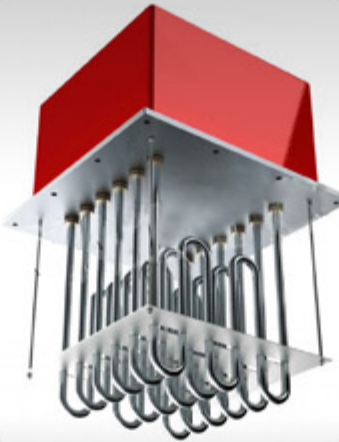
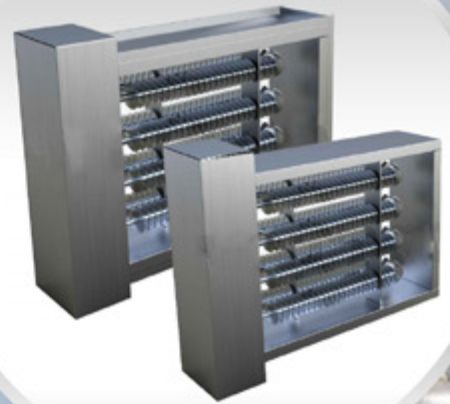
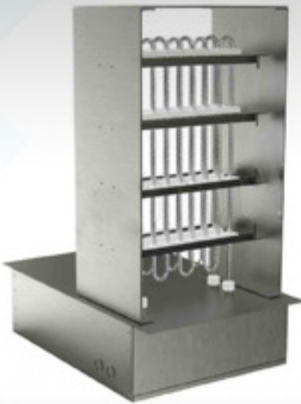

(1-800-492-8826)

www.wattco.com

DUCT HEATERS

air heaters

OVERVIEW

WATTCO™ duct heaters are composed of open coil, tubular or finned tubular heating elements that are either flanged or inserted in the duct. WATTCO™ supplies two types of duct heaters: air duct heaters and process heaters. Air duct heaters are primarily used in air flowing ventilation systems and comfort heating applications while process duct heaters are mainly used for industrial process heating applications (ovens that require re-circulated air or forced circulation).

WATTCO™ designs and configures your electric duct heaters according to your specifications. Our team is dedicated to research and development of the latest technologies, while striving to meet every customer's needs by manufacturing first class duct heaters. Our 50-year expertise in developing and manufacturing electric duct heaters make WATTCO™ duct heaters, the most easily adaptable solutions for most non-pressurized air-heating systems.

KEY FEATURES

- » 16-gauge satin coat steel
- » Exclusive modular construction with stock frame components used with 2" vertical and horizontal dimensional increments for faster delivery
- » Single and three-phase tensions
- » Stainless steel supports
- » Field replaceable heating elements, if required
- » ¼" (6 mm) inside diameter thermowell
- » 3 ½" (90 mm) thick insulation
- » General purpose terminal enclosure
- » Primary linear cutout:
 - 160°F (71°C)
 - 277/600 VAC
 - 25/10 AMP non-inductive
- » Secondary linear cutout:
 - Manual reset with back-up magnetic contactor on units of 300V, 30 kW and less
 - 225°F (107°C)
 - 277/600 VAC
 - 25/10 AMP non-inductive
- » Special sizes, wattages, and materials available upon request
- » Built stainless steel frames available upon request
- » American and Canadian Standards Associations (CSA, CSAus) certified

BENEFITS

- » Versatile
- » Corrosion and oxidation resistant
- » Easy to maintain
- » Easy to install
- » Durable
- » Compatible with local power supplies
- » Built for safety
- » Maximal dielectric strength and heat transfer
- » Minimal heat loss
- » Maintained wiring cooler
- » Clean heat
- » Easy service
- » Minimal downtime



APPLICATIONS

- » Heat treating
- » Forced air comfort heating
- » Booster air heater
- » Air drying operations
- » Core drying
- » Air pre-heating
- » Air handling equipment
- » Fan coils
- » Terminal reheating
- » Multizone reheating
- » Heat pump auxiliary systems
- » Return air heating
- » Resistor load banks
- » Annealing

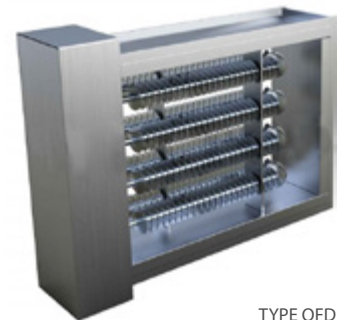

TYPE QFD



TYPE QID

SELECTING YOUR WATTCO™ AIR DUCT HEATER

APPLICATIONS	CONSTRUCTION TYPE	TUBULAR ELEMENTS	HEATER TYPE
Comfort heating	Flanged duct heater	Finned	QFD
Comfort heating	Insert duct heater	Finned	QID
Comfort heating	Flanged duct heater	Incoloy® (non-finned)	QFE
Comfort heating	Insert duct heater	Finned	QIE

Please call us at **1-800-4WATTCO (1-800-492-8826)** for further assistance.

DUCT HEATERS

air heaters

SELECTING YOUR WATTCO™ AIR DUCT HEATER

A broad range of custom built electric duct heaters with capacities up to 1000kW is available upon request. WATTCO™ heaters can be used for applications with the following voltages:

- » 347 volts/1 phase
- » 600 volts/1 phase
- » 600 volts/3 phases
- » 208/240 volts/1 phase
- » 208 volts/3 phases

WATTCO™ duct heaters have the international, American recognized, Canadian Standards Association (CSAus) label, which set the standards for the electric heating industry. Duct heater can include proper built-in safety devices to extend the service life of the heater.

WATTCO™ also manufactures heaters for industrial processes, original equipment manufacturers (OEM) or any other special applications.

KILOWATTS

Refer to Figure 3 to choose the appropriate kW for your application.

FIG. 1 - FINNED TUBULAR ELEMENT

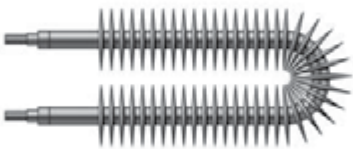
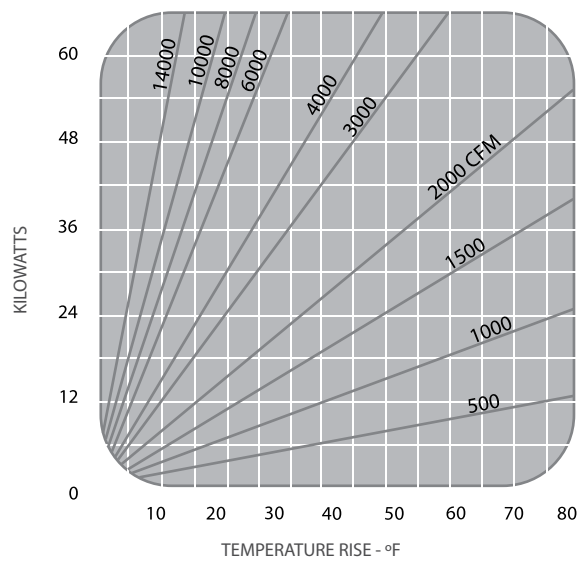

FIG. 2 - INCOLOY® UNFINNED TUBULAR ELEMENT



FIG. 3 - KILOWATTS



FINNED TUBULAR ELEMENTS vs INCOLOY® UNFINNED TUBULAR ELEMENTS

FINNED TUBULAR ELEMENTS	INCOLOY® UNFINNED TUBULAR ELEMENTS
The most common design	Available for approved special orders only
Include the highest wattage / cross sectional duct area	<ul style="list-style-type: none"> » Increase corrosion resistance » High humidity environments » Corrosive chemical contaminants in the air stream
Energy saver	Protect from electrical shock
Made of a steel tube with a corrugated steel fin wrapped around it and brazed together	Made of steel or stainless tube
Maximize the heat transfer surface of the element	Can be installed close to a register or grille
Provide lower operating temperature	N/A
Designed for low maintenance	Designed for low maintenance

Please call us at **1-800-4WATTCO (1-800-492-8826)** for further assistance.

DUCT HEATERS

air heaters

CONSTRUCTION

The two available basic heater frame constructions (Figures 4 and 5) are:

- » Insert type
- » Flange type

Notes:

- » Frames will be constructed with adequate thickness galvanized steel in order to provide sturdiness of the heater.
- » The mounting flanges for insertion provide an easy and safe fastening to the duct and do not require the main electrical control panel to be opened.
- » Heating elements are made of open nickel chrome.
- » High temperature resistant and first grade ceramics support coils horizontally.
- » Coils are machine-crimped onto galvanized terminal and secured by a ceramic socket which is resistant to anti-rotating high temperature.
- » All heaters are supplied with magnetic contactors and a primary automatic reset thermal cut-out to avoid overheating. Refer to the alternative auxiliary duct heater controls section on page 11.6 for a list of available controls.

TYPICAL DIMENSIONS

- » Insert type heaters: Undersized to allow duct installation with A and B dimensions, as shown in Table 1 on Page 5

FIG. 4 - INSERT TYPE



FIG. 5 - FLANGE TYPE

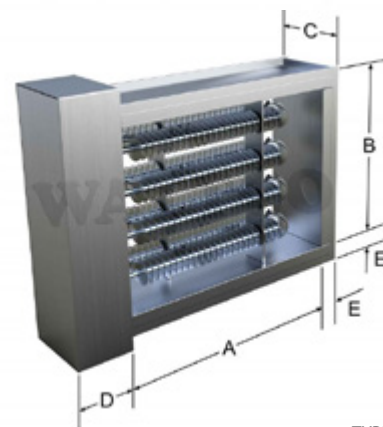
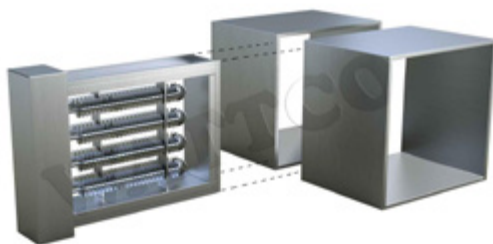

TYPE QFD

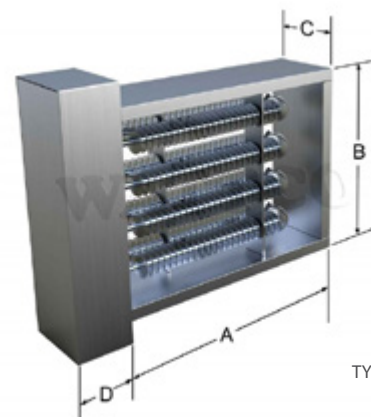

TYPE QID

DIM.	in.	mm
C	6 1/2	163
D	7	178
E	2	51

DUCT HEATERS

air heaters

QFD and QID Air Duct Heaters

- » Install the heaters in a horizontal duct with the terminal housing at the side or bottom.
- » Use tandem mounting (several heaters in series) when possible.

Note: Units in Table 2 are only examples. For safety reasons, refer to this table as a guideline for custom design orders. Custom designed units will be built according to the requirements of your specific application.

Note: QFE and QIE Incoloy® tubular duct heaters are only available upon request

COMMON FEATURES

- » Primary linear cutout: 160°F (71°C) 277/600 VAC, 25/10 AMP non-inductive
- » Secondary linear cutout - Manual reset complete with back-up magnetic contactor on units under 300V, 30 kW and less;
- » 225°F (107°C) 277/600 VAC, 25/10 AMP non-inductive

ALTERNATIVE AUXILIARY DUCT HEATER CONTROLS

The following controls are supplied by WATTCO™ on the duct heater or are available as an EEMAC rated control panel for wall mount:

- » Duct thermostats
 - QFD (1 stage)
 - QFD (2 stage)
 - QFD (0 -135 OHM)
- » Controller
- » Room thermostat
- » Bulb holders
- » Silent contactors
- » SCR controllers
- » Sail switch
- » Fixed pressure differential switch
- » Main disconnect
- » Pneumatic electric switches
- » On-off switch
- » Magnetic contactors
- » Step controllers
- » Load fuses
- » Stage fuses
- » HRC fusing
- » Control transformers
- » Bottom terminal box
- » Secondary manual reset thermal cut-out
- » Fan interlock relay
- » Protective screens
- » Pilot lights

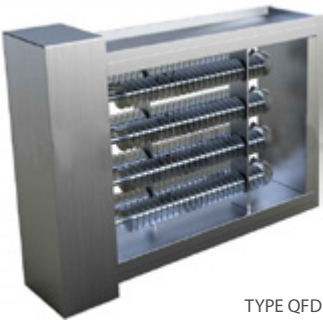

TYPE QFD



TYPE QID

TABLE 2
Types QFD/QID Duct Heaters with Finned Elements

KW	STANDARD VOLTAGES					DIMENSIONS IN. (MM)		MINIMUM AIR FLOW CFM (M ³ /MIN)	NO. OF ELEMS.	CATALOG FLANGE TYPE / QFD	NUMBERS INSERT TYPE / QID	APPROX. WEIGHT LBS (KG)
	120V 1φ	208V 1φ	240V 3φ	480V 1φ	600V 3φ	A	B					
1	✓	✓	—	—	—	6 (152)	6 (152)	50 (1.4)	2	QFD0010	QID0010	15 (7)
2.5	✓	✓	✓	—	—	6 (152)	6 (152)	150 (4.2)	3	QFD0025	QID0025	15 (7)
7.5	—	✓	✓	✓	✓	14 (356)	8 (203)	390 (11.0)	4	QFD0075	QID0075	20 (9)
10	—	✓	✓	✓	✓	14 (356)	12 (305)	500 (14.1)	6	QFD0100	QID0100	25 (11)
12.5	—	✓	✓	✓	✓	16 (406)	12 (305)	625 (17.7)	6	QFD0125	QID0125	30 (14)
15	—	✓	✓	✓	✓	18 (457)	12 (305)	750 (21.2)	6	QFD0150	QID0150	30 (14)
17.5	—	✓	✓	✓	✓	18 (457)	14 (356)	875 (24.8)	6	QFD0175	QID0175	35 (16)
20	—	✓	✓	✓	✓	18 (457)	16 (406)	1000 (28.3)	6	QFD0200	QID0200	35 (16)
25	—	—	✓	✓	✓	20 (508)	18 (457)	1250 (35.4)	9	QFD0250	QID0250	50 (23)
30	—	—	✓	✓	✓	24 (610)	18 (457)	1500 (42.4)	9	QFD0300	QID0300	55 (25)
35	—	—	✓	✓	✓	24 (610)	22 (559)	1650 (46.7)	9	QFD0350	QID0350	60 (27)
40	—	—	✓	✓	✓	26 (660)	24 (610)	2050 (58.0)	12	QFD0400	QID0400	70 (32)
45	—	—	✓	✓	✓	28 (711)	24 (610)	2200 (62.2)	12	QFD0450	QID0450	75 (34)
50	—	—	✓	✓	✓	28 (711)	26 (660)	2500 (70.7)	12	QFD0500	QID0500	80 (36)
60	—	—	✓	✓	✓	30 (762)	30 (762)	3000 (84.9)	15	QFD0600	QID0600	95 (43)
80	—	—	✓	✓	✓	36 (914)	32 (813)	4000 (113.1)	15	QFD0800	QID0800	105 (48)
100	—	—	✓	✓	✓	42 (1067)	36 (914)	5250 (148.5)	18	QFD1000	QID1000	130 (59)
120	—	—	✓	✓	✓	48 (1219)	36 (914)	6000 (170.0)	18	QFD1200	QID1200	150 (68)

DUCT HEATERS

air heaters

OVERVIEW

WATTCO™ process duct heaters are installed in forced air ducts and used for industrial processes (forced air dryers, core drying, annealing) that require medium to high air temperature (at least 750°F/400°C).

Process duct heaters come with the same standard and optional features as air duct heaters.

Please call us at **1-800-4WATTCO (1-800-492-8826)** for further assistance in selecting the best WATTCO™ process duct heater for your application.

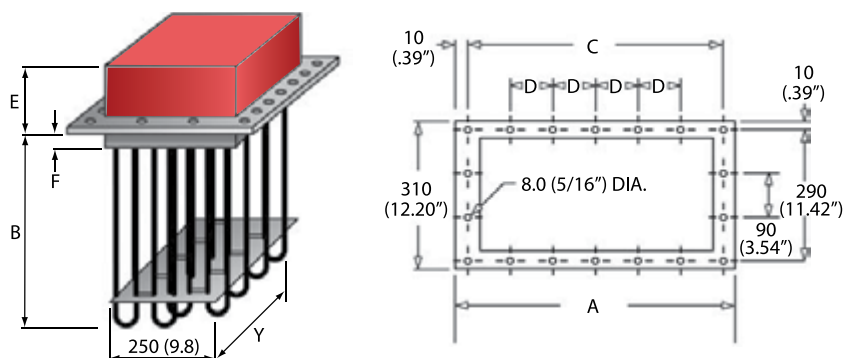

MODEL	W/cm	W/in.	B DIM. mm (in.)	E DIM. mm (in.)	F DIM. mm (in.)
AMT	4.2	27	410 (16.1)	150 (5.9)	35 (1.4)
AML	4.2	27	410 (16.1)	250 (9.8)	00
AML	3.1	20	530 (20.9)	250 (9.8)	51

TABLE 3
Process Duct Heaters

KW	STANDARD VOLTAGES				A DIM. mm (in.)	C DIM. mm (in.)	D DIM. mm (in.)	Y DIM. mm (in.)	CAT. NO.	NET WT. LBS (KG)
	208 1φ	240 3φ	480 1φ	600 3φ						
TYPE AMT - INTERMEDIATE TEMPERATURE DESIGN - 27 W/in.² (4.2 W/cm²)										
6	✓	✓	✓	✓	155 (6.1)	135 (5.3)	—	110 (4.3)	AMT-6X	15.4 (7)
12	✓	✓	✓	✓	235 (9.3)	215 (8.5)	—	190 (7.5)	AMT-12X	26.5 (12)
18	✓	✓	✓	✓	310 (12.2)	290 (11.4)	50 (1.97)	265 (10.4)	AMT-18X	39.7 (18)
24	—	✓	✓	✓	385 (15.2)	365 (14.4)	90 (3.54)	340 (13.4)	AMT-24X	48.5 (22)
30	—	✓	✓	✓	460 (18.1)	440 (17.3)	110 (4.33)	415 (16.3)	AMT-30X	57.3 (26)
36	—	✓	✓	✓	540 (21.3)	520 (20.5)	130 (5.12)	495 (19.5)	AMT-36X	63.9 (29)
42	—	✓	✓	✓	615 (24.2)	595 (23.4)	150 (5.90)	570 (22.4)	AMT-42X	72.8 (33)
48	—	✓	✓	✓	690 (27.2)	670 (26.4)	170 (6.69)	645 (25.4)	AMT-48X	79.4 (36)
54	—	✓	✓	✓	765 (30.1)	745 (29.3)	185 (7.28)	720 (28.3)	AMT-54X	86.0 (39)
60	—	✓	✓	✓	840 (33.1)	820 (32.3)	205 (8.07)	800 (31.5)	AMT-60X	92.6 (42)
72	—	✓	✓	✓	990 (39.0)	970 (38.2)	160 (6.30)	950 (37.4)	AMT-72X	105.8 (48)
84	—	✓	✓	✓	1140 (44.9)	1120 (44.1)	185 (7.28)	1100 (43.3)	AMT-84X	119.1 (54)
TYPE AML - HIGH TEMPERATURE DESIGN (UP TO 950°F OUTLET TEMP.) - 27 W/in.² (4.2 W/cm²)										
12	✓	✓	✓	✓	235 (9.3)	215 (8.5)	—	190 (7.5)	AML-12X	28.7 (13)
18	✓	✓	✓	✓	310 (12.2)	290 (11.4)	50 (1.97)	265 (10.4)	AML-18X	41.9 (19)
24	—	✓	✓	✓	385 (15.2)	365 (14.4)	90 (3.54)	340 (13.4)	AML-24X	55.1 (25)
36	—	✓	✓	✓	540 (21.3)	520 (20.5)	130 (5.12)	495 (19.5)	AML-36X	68.3 (31)
48	—	✓	✓	✓	690 (27.2)	670 (26.4)	170 (6.69)	645 (25.4)	AML-48X	81.6 (37)
60	—	✓	✓	✓	840 (33.1)	820 (32.3)	205 (8.07)	800 (31.5)	AML-60X	94.8 (43)
72	—	✓	✓	✓	990 (39.0)	970 (38.2)	160 (6.30)	950 (37.4)	AML-72X	108.0 (49)
84	—	✓	✓	✓	1140 (44.9)	1120 (44.1)	185 (7.28)	1100 (43.3)	AML-84X	121.3 (55)
TYPE AML - HIGH TEMPERATURE DESIGN (UP TO 1100°F OUTLET TEMP.) - 20 W/in.² (3.1 W/cm²)										
12	✓	✓	✓	✓	235 (9.3)	215 (8.5)	—	190 (7.5)	AML-12Y	30.9 (14)
18	✓	✓	✓	✓	310 (12.2)	290 (11.4)	50 (1.97)	265 (10.4)	AML-18Y	44.1 (20)
24	—	✓	✓	✓	385 (15.2)	365 (14.4)	90 (3.54)	340 (13.4)	AML-24Y	57.3 (26)
36	—	✓	✓	✓	540 (21.3)	520 (20.5)	130 (5.12)	495 (19.5)	AML-36Y	70.5 (32)
48	—	✓	✓	✓	690 (27.2)	670 (26.4)	170 (6.69)	645 (25.4)	AML-48Y	83.8 (38)
60	—	✓	✓	✓	840 (33.1)	820 (32.3)	205 (8.07)	800 (31.5)	AML-60Y	97.0 (44)
72	—	✓	✓	✓	990 (39.0)	970 (38.2)	160 (6.30)	950 (37.4)	AML-72Y	110.2 (50)
84	—	✓	✓	✓	1140 (44.9)	1120 (44.1)	185 (7.28)	1100 (43.3)	AML-84Y	123.5 (56)

WHEN ORDERING, PLEASE SPECIFY: Quantity, catalogue number, tension, wattage, shop drawings, and extra features.