

# WATTCO™

Manufacturer of Electric Heating Elements and Controls

## CONTROL PANELS controls

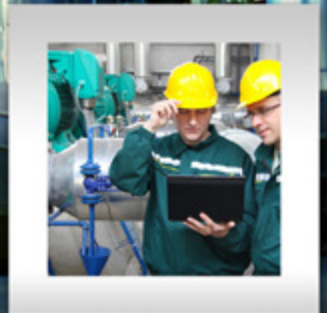
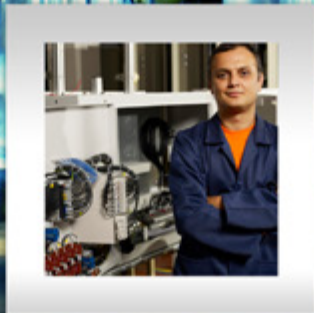
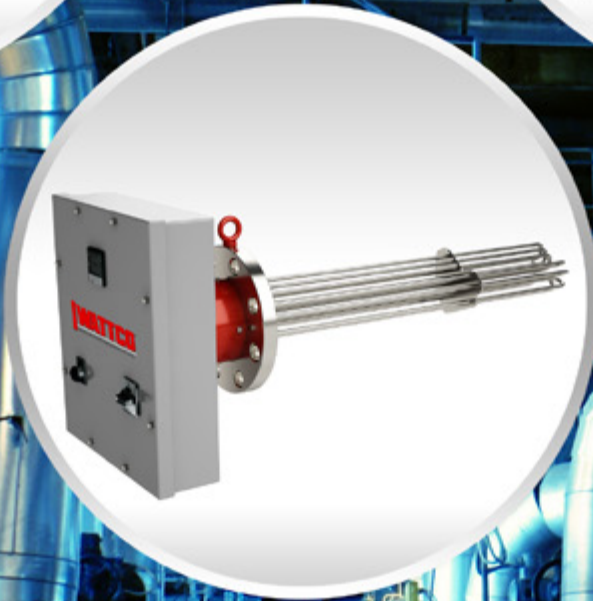
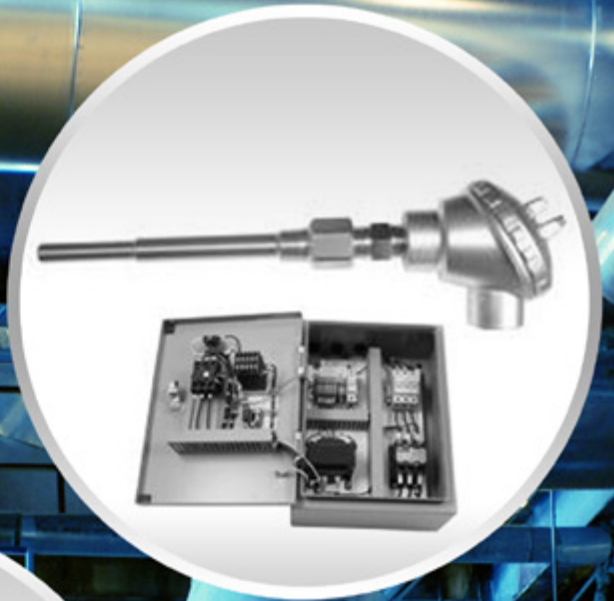

(1-800-492-8826)

[www.wattco.com](http://www.wattco.com)

# CONTROL PANELS

## controls

### OVERVIEW

Convenient and ready-to-connect, WATTCO™ control panels include temperature, power, multi-loop, process, and safety limit controllers. Designed for electric heaters, control panels are composed of switching devices, fusing, and internal wiring. Control panels can be custom designed to meet the requirements of your application.

### BENEFITS

- » Reliable
- » Cost effective
- » Ready-to-connect
- » Compatible with different materials (dust, oil, water, corrosive, dangerous materials)

The following sections will help you select the WATTCO™ control panel that meets the requirements of your application.

Please call us at **1-800-4WATTCO (1-800-492-8826)** for further assistance.

### KEY FEATURES

- » Control panels with voltages up to 4000 amps, 600V
- » Basic model: TE (remote mounted controls available upon request)
- » Fully-equipped models:
  - Contactor power switching
  - Stage contactor
  - Solid state switching
- » Package includes:
  - Design drawings
  - Bills of material
  - Replacement parts
  - Operating instructions
  - Component manuals



### EXTRA FEATURES

- » Remote set point
- » Proportioning
- » Process variable retransmission
- » Alarms
- » Remote annunciation
- » Dual energy and peak load controls
- » Current/voltage/wattage metering and interfacing PLCs

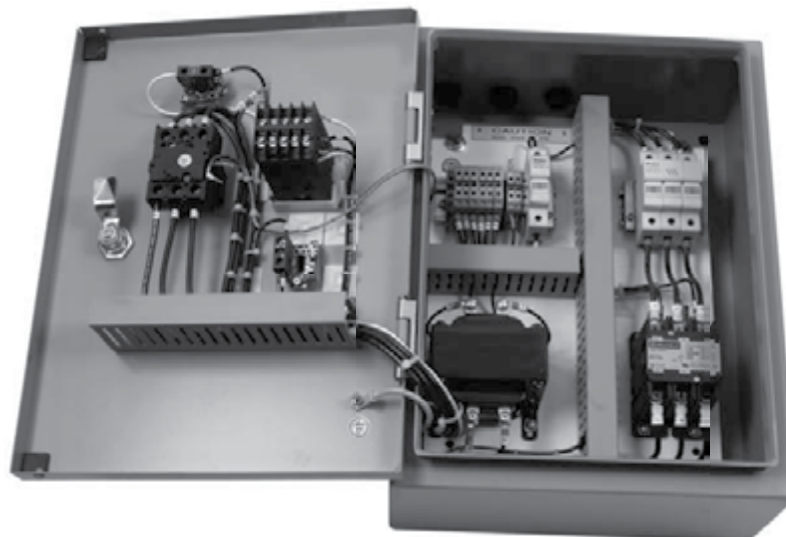

# CONTROL PANELS

## controls

### SELECTING YOUR WATTCO™ CONTROL PANEL - TE4 CONTROL PANELS

CONTROL PANEL TYPE	STANDARD FEATURES	EXTRA FEATURES
	Basic control units for electric heaters with thermostats, limit controls, percentage timers or other control components.	
	<b>Panels include:</b>	
TE4	<ul style="list-style-type: none"> <li>» Type 4 weather resistant enclosure (hinged door)</li> <li>» Fused magnetic contactor(s)</li> <li>» On-off switch and pilot light</li> <li>» Fused control circuit transformer including 120V secondary control voltage</li> <li>» Terminal blocks for external control devices</li> </ul>	N/A

TABLE 1

**Type TE4 Control Panels (Type 4 Enclosures)** 208V, 240V, 480V, 600V (1 or 3 PHASE)

FUSED RATING (Amps)	MAX LOAD (Amps)	NO. OF CIRCUITS	AMPS PER CIRCUIT	PANEL SIZE (ins.)	CATALOG NUMBER
30	24	1	24	16X12X6	TE43024
40	32	1	32	16X12X6	TE44032
50	40	1	40	16X12X6	TE45040
60	48	1	48	16X12X6	TE46048
80	64	2	32	20X16X6	TE48064
100	80	2	40	20X16X6	TE410080
150	120	3	40	24X20X6	TE4150120
200	160	4	40	24X20X6	TE4200160

**WHEN ORDERING, PLEASE SPECIFY:** Catalogue number and extra features.

### SELECTING YOUR WATTCO™ CONTROL PANEL - TE1 CONTROL PANELS

CONTROL PANEL TYPE	STANDARD FEATURES	EXTRA FEATURES
	Ideal for various electric heater installations.	
	<b>Panels include:</b>	
TE1	<ul style="list-style-type: none"> <li>» Type 4 weather resistant enclosure (hinged door)</li> <li>» Disconnect switch including door interlock</li> <li>» Fused magnetic contactor(s) for definite purpose</li> <li>» On-off switch</li> <li>» Fused control circuit transformer including 120V secondary control voltage</li> <li>» Digital indicating configurable processor based temperature control</li> <li>» Electronic high limit (manual or auto reset)</li> <li>» Pilot lights: "heat on"; "system on"; "high limit"</li> </ul>	N/A

TABLE 2

**Type TE1 Control Panels (Type 4 Enclosures)** 208V, 240V, 480V, 600V (1 or 3 PHASE)

FUSED RATING (Amps)	MAX LOAD (Amps)	NO. OF CIRCUITS	AMPS PER CIRCUIT	PANEL SIZE (ins.)	CATALOG NUMBER
30	24	1	24	24X20X8	TE13024
60	48	1	48	24X20X8	TE16048
100	80	2	40	24X20X8	TE110080
200	160	4	40	36X24X8	TE1200160

**WHEN ORDERING, PLEASE SPECIFY:** Catalogue number, voltage, phase, temperature range, type of sensor, alternative high limits, and extra features.

# CONTROL PANELS

## controls

SELECTING YOUR WATTCO™ CONTROL PANEL

### TE6 CONTROL PANELS - CONTACTOR STAGES

CONTROL PANEL TYPE	STANDARD FEATURES	EXTRA FEATURES
TE6 Contactor stages	<p>Suitable for multi-stages heaters.</p> <p><b>Panels include:</b></p> <ul style="list-style-type: none"> <li>» A modulating temperature control with step control, bringing contactor stages</li> <li>» Type 12 dust tight enclosure</li> <li>» Disconnect with door interlock</li> <li>» 2-12 fused contactors</li> <li>» Fused control circuit transformer</li> <li>» On/off selector switch and pilot light</li> <li>» High limit trip pilot light</li> <li>» Digital indicating control (on site or factory configurable)</li> <li>» Manual reset limit</li> </ul>	<p>Type 4 weather resistant enclosure</p> <p>Call us at <b>1-800-4WATTCO (1-800-492-8826)</b> for additional components and features.</p>

TABLE 3

#### Type TE6 Control Panels (Contactor Stages)

DISCONNECT RATING	LOAD RATING	STAGES	CATALOG NUMBER
100	80	2	TE610002
100	80	4	TE610004
200	160	4	TE620004
200	160	6	TE620006
400	320	6	TE640006
400	320	8	TE640008
400	320	12	TE640012

**Note:**

- » Standard size stages: 30-45 amps
- » Standard process control: 4-20 mA
- » High limit: manual reset, including K thermocouple for -20 - +1100°C

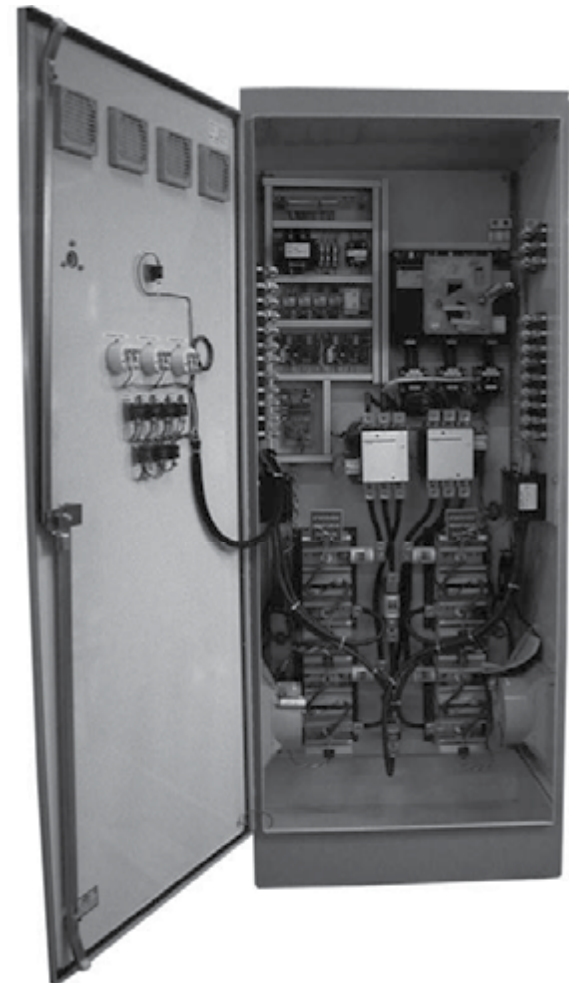

**NEED ASSISTANCE?**

Please call us at **1-800-4WATTCO (1-800-492-8826)** if you need further assistance in selecting the control panel that best suits the requirements of your application.

**WHEN ORDERING, PLEASE SPECIFY:** Catalogue number, voltage, phase, number of stages, configuration, and extra features.

# CONTROL PANELS

## controls

SELECTING YOUR WATTCO™ CONTROL PANEL

### TE8 CONTROL PANELS - BASE LOAD –SCR

CONTROL PANEL TYPE	STANDARD FEATURES	EXTRA FEATURES
TE8 Based load – SCR	Contactor stages controlled by a step control and SCR solid-state power control. <b>Panels include:</b> <ul style="list-style-type: none"> <li>» Type 12 dust tight enclosure</li> <li>» Disconnect with door interlock</li> <li>» Fused contactors</li> <li>» Fused control circuit transformer</li> <li>» On/off selector switch and pilot light</li> <li>» High limit trip pilot light</li> <li>» Heating stages pilot light</li> <li>» Process control</li> <li>» Manual reset limit</li> </ul>	Type 4 weather resistant enclosure  Call us at <b>1-800-4WATTCO (1-800-492-8826)</b> for additional components and features.

TABLE 4

#### Type TE8 Control Panel (baseload & SCR)

MAXIMUM STAGES & AMPS			
DISCONNECT RATING	BASE LOADS	SCR RATING	CATALOG NUMBER
175A	4X30A	60A	TE8175SCR60
400A	6X50A	90A	TE8400SCR90
600A	8X60A	120A	TE8600SCR120
800A	10X60A	180A	TE8800SCR180
800A	12X50A	180A	TE8800SCR180

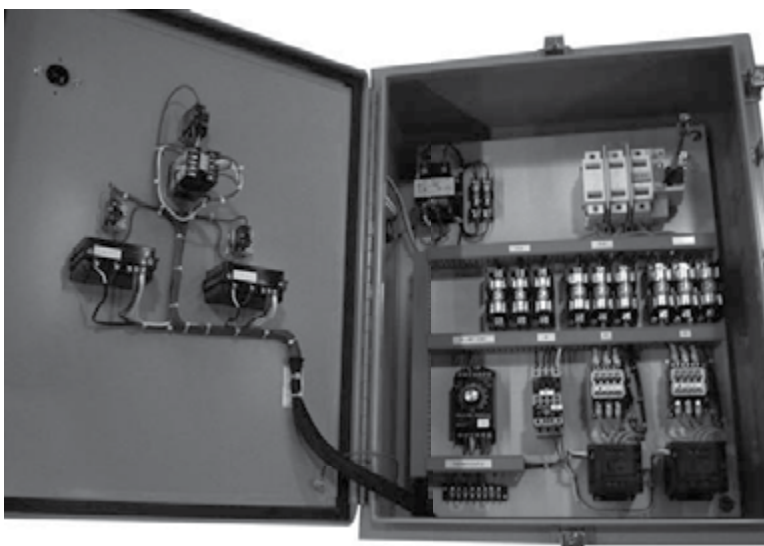

#### NEED ASSISTANCE?

Please call us at **1-800-4WATTCO (1-800-492-8826)** if you need further assistance in selecting the control panel that best suits the requirements of your application.

**WHEN ORDERING, PLEASE SPECIFY:** Catalogue number, voltage, phase, number of stages, configuration, and extra features.

# CONTROL PANELS

## controls

SELECTING YOUR WATTCO™ CONTROL PANEL

### TE9 CONTROL PANELS

CONTROL PANEL TYPE	STANDARD FEATURES	EXTRA FEATURES
TE9	<p><b>Panels include:</b></p> <ul style="list-style-type: none"> <li>» SCR control</li> <li>» Multiple backup contactors</li> <li>» Type 12 dust tight enclosure</li> <li>» Disconnect with door interlock</li> <li>» Fused backup contactors</li> <li>» Fused control circuit transformer</li> <li>» On/off selector switch and pilot light</li> <li>» I<sup>2</sup>T fused SCR</li> <li>» High limit trip pilot light</li> <li>» Process control</li> <li>» Manual reset limit</li> </ul>	<p>Type 4 weather resistant enclosure</p> <p>Fans and vents can be included with type 12 dust tight enclosure</p> <p>Call us at <b>1-800-4WATTCO (1-800-492-8826)</b> for additional components and features.</p>

TABLE 5

#### Type TE9 Control Panel

DISCONNECT RATING	BACKUP CONTACTORS	SCR	CATALOG NUMBER
30A	1X30A	25A	TE903025
80A	2X30A	70A	TE908070
100A	2X50A	90A	TE9100090
175A	3X50A	120A	TE9175120
200A	4X50A	180A	TE9200180
400A	8X50A	350A	TE9400350
600A	10X60A	500A	TE9600500
800A	14X60A	650A	TE9800650

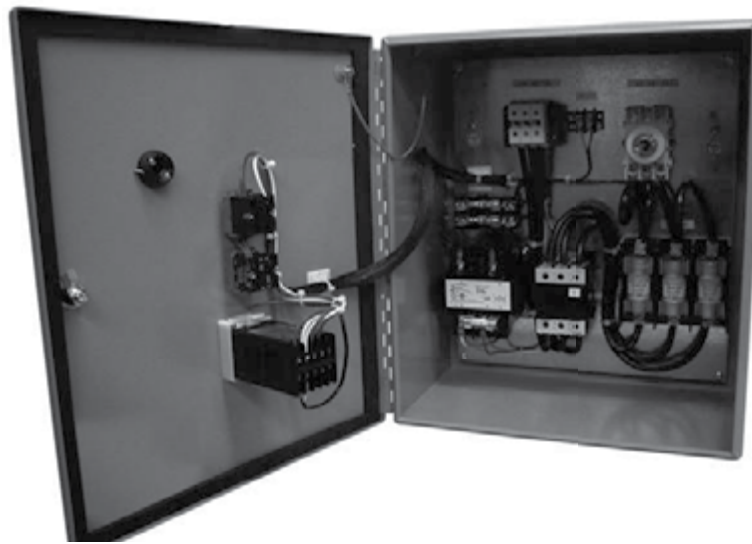

#### NEED ASSISTANCE?

Please call us at **1-800-4WATTCO (1-800-492-8826)** if you need further assistance in selecting the control panel that best suits the requirements of your application.

**WHEN ORDERING, PLEASE SPECIFY:** Catalogue number, voltage, phase, number of stages, configuration, and extra features.

# CONTROL PANELS

## controls



**TBR THERMOSTATS**



**REOSTATS**



**THI HIGH LIMITS**

ACCESSORIES TYPE	APPLICATIONS
------------------	--------------

TBR Industrial thermostats  
Industrial applications with no required close control of process temperatures.

### STANDARD FEATURES

**Bulbs and capillaries:**

- » Copper with nickel plating
- » Stainless

Protective well or sleeving required for corrosive applications DPST controls with 3/8" diameter bulbs, supplied with nonremovable 3/8" NPT compression fitting.

For controls with no built-in fitting, please call us at **1-800-4WATTCO (1-800-492-8826)**

**Note:**

- » S.P.S.T. switches have a thermostatically opened double pole and are mechanically opened single pole in the OFF position.
- » Inverse acting D.P.S.T. switches are provided with a single thermostatic pole. Poles open mechanically in the OFF position.



**30 AMP SPECIAL HIGH AMPERAGE THERMOSTAT**

WHEN ORDERING, PLEASE SPECIFY: Quantity, catalogue number, and extra features.

ACCESSORIES TYPE	APPLICATIONS
------------------	--------------

THI High Limits  
Industrial processes with potential safety risks or damage due to control malfunction, loss of liquid level or airflow. Use with a control thermostat is mandatory.

### CONSTRUCTION

With a screwdriver adjustment for tampering prevention. When the limit temperature is achieved, contacts open and remain open until the temperature is below the control setting and the control reset button is deactivated.

### WIRING

Closed one pole and one throw device. On temperature rise: pole and throw open up. Limits include: 240V neon pilot light for 120-240V VAC circuits. Pilot light is wired to light if the high limit temperature is reached. (See picture )

TABLE 1

**Type THI High Limits**

TEMP. RANGE		BULB SIZE (ins.)	CATALOG NUMBER
°F	°C		
<b>120 VAC 25 Amp / 240V 22AMP S.P.S.T. - Open On Rise</b>			
110-500	40-260	5/16 x 3	THI0204
250-650	120-340	5/16 x 3	THI0208

WHEN ORDERING, PLEASE SPECIFY: Quantity, catalogue number, and extra features.

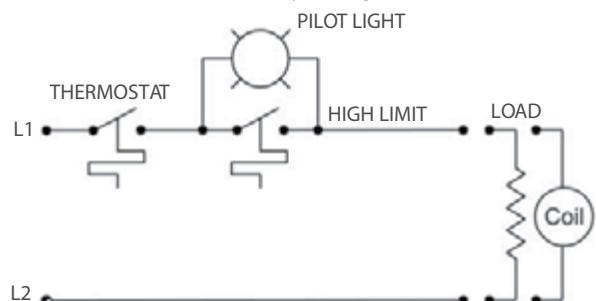

# CONTROL PANELS

## controls



### **PART# G4-4911 - Thermostat with Capillary - Double Pole Thermostat D.P.D.T.**

- » Thermostatic controls (10°C - 120°C)
- » Bulb and Capillary
- » 240 VAC or less, 25 Amp. 6 foot capillary differential  $\pm 15\%$  of scale range
- » Contacts open on temperature rise



### **PART# G4-4915 - Thermostat with Capillary - Double Pole Thermostat D.P.D.T.**

- » Thermostatic controls (70°C - 280°C)
- » Bulb and Capillary
- » 240 VAC or less, 25 Amp. 6 foot capillary differential  $\pm 15\%$  of scale range
- » Contacts open on temperature rise



### **PART# G1-4909 - Thermostat with Capillary - Single Pole Thermostat, Single Throw S.P.S.T**

- » Thermostatic controls (10°C - 120°C)
- » Bulb and Capillary
- » 240 VAC or less, 25 Amp. 6 foot capillary differential  $\pm 15\%$  of scale range
- » Contacts open on temperature rise



### **PART# G1-4913 - Thermostat with Capillary - Single Pole Thermostat, Single Throw S.P.S.T**

- » Thermostatic controls (70°C - 280°C)
- » Bulb and Capillary
- » 240 VAC or less, 25 Amp. 6 foot capillary differential  $\pm 15\%$  of scale range
- » Contacts open on temperature rise



# CONTROL PANELS

## controls

### PART# G1-4675 - Thermostat with Capillary - Single Pole Thermostat, Single Throw S.P.S.T

- » Thermostatic controls (10°C - 120°C) with 3/8" NPT compression fitting
- » Bulb and Capillary
- » 240 VAC or less, 25 Amp. 6 foot capillary differential  $\pm 15\%$  of scale range
- » Contacts open on temperature rise



### PART# G4-600 - Thermostat with Capillary - Double Pole Thermostat, Single Throw

- » Thermostatic controls (10°C - 120°C)
- » Bulb and Capillary
- » 600 VAC or less, 25 Amp. 6 foot capillary differential  $\pm 15\%$  of scale range
- » Contacts open on temperature rise



### PART# WAT-1-4909 - Thermostat with Capillary - Special High Amperage Thermostat

- » Thermostatic controls (20°C - 120°C) (40°C - 250°F)
- » Capillary length 1830mm (stainless steel), Bulb 7.94mm x 166mm long (stainless steel)
- » Single Pole, Single Throw
- » Differential:  $\pm 4^\circ\text{C}$  - 30 AMP 220V 60 Cy.
- » Dimensions: 2 3/4" (70mm) x 1 7/8" (48mm)



### PART# WAT-1-4913 - Thermostat with Capillary - Special High Amperage Thermostat

- » Thermostatic controls (70°C - 280°C) (150°C - 550°F)
- » Capillary length 1830mm (stainless steel), Bulb 7.94mm x 166mm long (stainless steel)
- » Single Pole, Single Throw
- » Differential:  $\pm 4^\circ\text{C}$  - 30 AMP 220V 60 Cy.
- » Dimensions: 2 3/4" (70mm) x 1 7/8" (48mm)



# CONTROL PANELS

## controls

### THERMOSTAT ACCESSORIES

#### NEON PILOT LIGHT

Separate shipping for field mounting and wiring.  
Standard lights for 120-240 VAC.  
(figure 1)



FIG. 1

#### PROTECTIVE WELLS

Supplied as a standard feature as a welded Incoloy® tube type with stainless bushing. Wells are ideal for normal processes.

For corrosive applications, request for a special bar stock wells.

**Note:** Call us at **1-800-4WATTCO (1-800-492-8826)** for special features or configurations.

TABLE 2

#### Protective Wells

LENGTH B DIM.	INSIDE THREAD	MOUNTING THREAD	CAT. NUMBER
12"			WELL01
24"	3/8" NPT	1/2" NPT	WELL02
36"			WELL03



**WHEN ORDERING, PLEASE SPECIFY:** Quantity, catalogue number, and extra features.

TABLE 3

#### SLEEVING

**SLEEVING**  
Option available for covering the bulb and capillary of the thermostat in order to prevent corrosion. Sleeveings listed in the table below are 84" long.

BULB STYLE	SUPPLIED	MAT'L	MAX TEMP	CAT. NUMBER
4 (3/8" DIA.)	LOOSE	PVC	95°C (203°F)	SLO12415
4 (3/8" DIA.)	INSTALLED	"	"	SLO12416
9 (3/16" DIA.)	LOOSE	"	"	SLO12417
9 (3/16" DIA.)	INSTALLED	"	"	SLB13415
4 (3/8" DIA.)	LOOSE	TEFLON	200°C (392°F)	SLB13416
4 (3/8" DIA.)	LOOSE	"	"	SLB13417

### B-200 SERIES – SURFACE MOUNTING TEMPERATURE CONTROLLERS

#### Features

- » B-200 series surface mounting thermostats function according to expanding metals.
- » Temperature change is detected when expanding metals touch the heated surface.
- » When the temperature rises, contacts open up.

TABLE 4

#### B-200

APPROX. TEMP. RANGE AND FACTORY SETTING TOLERANCE	CURRENT RATING*	CAT. NUMBER
50 to 300°F ± 5°F or 3% of setting value	10 Amps	B200-B
85 to 250°F ± 5°F or 3% of setting value	5 Amps	B200-B
50 to 600°F ± 10°F or 3% of setting value	240 VAC Resistive	B200-C

**WHEN ORDERING, PLEASE SPECIFY:** Quantity, catalogue number, and extra features.

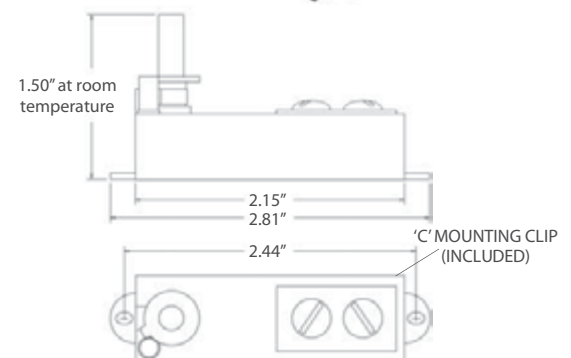
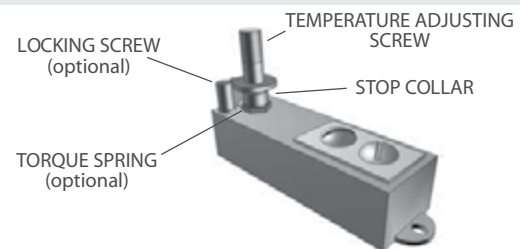

# CONTROL PANELS

## controls

### STANDARD THERMOCOUPLES

» Sensing devices used with electronic controls  
 Call us at **1-800-4WATTCO (1-800-492-8826)** for special features or configurations.

TABLE 1  
 Standard Thermocouples

ANSI TYPE	PROBE LENGTH	LEAD LENGTH	LEAD TYPE	FIG.	CAT. NUMBER
J	3"	72"	FIBERGLASS	1	OJ07203F
J	6"	72"	"	1	OJ07206F
J	12"	72"	"	1	OJ07212F
J	18"	72"	"	1	OJ07218F
J	24"	72"	"	1	OJ07224F
J	3"	72"	PVC/ARMOUR	2	OJ07203P
J	6"	72"	"	2	OJ07206P
K	12"	72"	FIBERGLASS	1	OK07212F
K	18"	72"	"	1	OK07218F
K	24"	72"	"	1	OK07224F
J	3"	72"	PVC	3	OJ07203P
J	3"	72"	ARMOUR	4	OJ07203A
J	ADJ	72"	"	5	OJ0720AA
J	—	48"	—	6	OJ048299
J	1 1/8"	—	TERM. ENCL.	7	OJ01T315
J	1 5/8"	—	"	7	OJ01U350
J	2 7/8"	—	"	7	OJ01V350

TABLE 2  
 Control Sensor Accessories

DESCRIPTION	FIG.	CAT. NUMBER
1/8" NPT BAYONET ADAPTOR	8	V5001
1/4" NPT COMPRESSION FITTING	9	V5002
PIPE CLAMP ADAPTOR	—	V5003
J PLUG (BLACK)	10	V5004
J JACK (BLACK)	10	V5005
K PLUG (YELLOW)	10	V5006
K JACK (YELLOW)	10	V5007

### THERMOCOUPLE WELL ASSEMBLIES

- » Used in tanks applications
- » Solid single piece device to detect liquid temperatures
- » Terminal enclosure suitable for outdoor, dusty, oily or damp locations
- » Steel or stainless steel wells

TABLE 3  
 Thermocouple Wells

ANSI TYPE	PROCESS FITTING	WELL MAT'L	DIMENSIONS			CAT. NUMBER
			B	C	D	
j	3/4" NPT	STEEL	18"	.840	5 3/4"	WELL018751
j	3/4" NPT	304 SS	18"	.840	5 3/4"	WELL118751
j	1/2" NPT	304 SS	6"	.540	6 1/4"	WELL106501
j	3/4" NPT	304 SS	4 1/2"	.540	2 1/2"	WELL104751
j	1/2" NPT	316 SS	6"	.540	1 1/2"	WELL106502

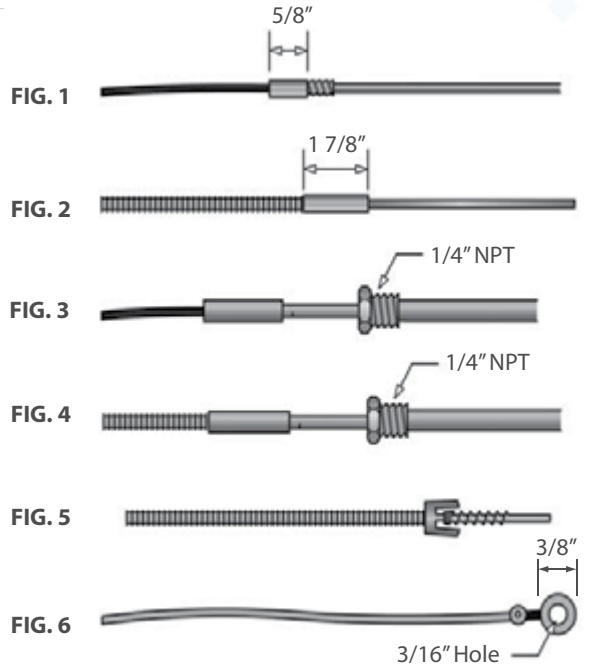

**SERIES 100**  
 Electronic Indicating Controls



FIG. 7



FIG. 8



FIG. 9



FIG. 10



Call us at **1-800-4WATTCO (1-800-492-8826)** for special enclosures and custom bar stock well assemblies.

**WHEN ORDERING, PLEASE SPECIFY:** Quantity, catalogue number, and extra features.

# CONTROL PANELS

## controls

TABLE 4

Thermocouple / Instrumentation Extension Wire

GAUGE	ANSI TYPE	FIG.	INSULATION TEMPERATURE	CAT. NUMBER
16	JX	11	PVC 105°C	OJS162P
20	JX	11	"	OJS203P
16	KX	11	"	OXS164P
20	KX	11	"	OXS205P
16	KX	12	G-GLAS, 510°C	OXS166G
20	KX	12	FIBERGLASS	OXS207F

WHEN ORDERING, PLEASE SPECIFY: Quantity, catalogue number, and extra features.

### JUNCTIONS

Various junction constructions measurements can be done according to the application.

#### Grounded junction

- » Made by welding in an inert atmosphere to allow the two thermocouple wires to be incorporated to the sheath weld closure.
- » Wires are grounded to the sheath.
- » Features:
  - Slower response than exposed wire.
  - Pressure tight above 100,000 psi.
  - Wires are protected from mechanical damage.
  - Wires are not exposed to environment and will last longer.
  - Coefficient of expansion wire must be similar to that of sheath in order to avoid pulling part of hot junction.

#### Ungrounded junction

- » Similar construction as grounded junction except that the thermocouple wires are first made into a junction, then insulated from the sheath and the sheath closure.
- » The closure is shaped by welding without the thermocouple wires.
- » The thermocouple is "ungrounded" in relation to the sheath material.
- » Features:
  - Slower response than exposed wire.
  - Pressure tight above 100,000 psi.
  - Wires are protected from mechanical damage.
  - Wires are not exposed to environment and will last longer.
  - Differential expansion between wires and sheath.

#### Weld pad junction

- » Used as a fastening means for thermocouples to surfaces (plates and tubes) to provide efficient surface temperature measurement.
- » Standard alloy pad: 1" x 1" x 1/8".
- » Same composition as the sheath.
- » Available skins: parallel, perpendicular and tube.

### THERMOCOUPLE WIRE

FIG. 11



FIG. 12



FIG. 13



#### Exposed junction

- » Thermocouple wires are exposed due to the removal of the sheath and the insulating material.
- » Wires are joined to make a measuring junction.
- » The junction is of a but-weld type.
- » Features:
  - Faster response.
  - Exposed magnesium will be affected by moisture.
  - Not pressure tight.
  - Wires are subjected to mechanical damage.
  - Wires are exposed to environment and will have shorter service life.
  - Useful life shortened resulting from rapid calibration.

#### THE TRANSITION

WATTCO™ transition protects the splice between the extension wires and thermocouple wires from:

- » Moisture
- » Vibration
- » Mechanical damage

Standard transitions can be used in the following temperature ranges: -185°C – 250°C (-300°F – 500°F).

Standard potting adaptor: 5/16 diameter X 1" long.

# CONTROL PANELS

## controls

CALIBRATION TYPE				
ANSI TYPE	FEATURES	TEMPERATURE RANGE °C	TOLERANCE GRADE	
			STANDARD	SPECIAL
K (Chromel + vs. Alumel)	<ul style="list-style-type: none"> <li>» The most popular industrial model</li> <li>» Reliable and accurate to 1260°C</li> <li>» Can be used in oxidizing, inert and reducing atmospheres</li> <li>» Must be protected from sulfurous or "green-rot" corrosio atmospheres as it can result in negative calibration errors</li> </ul>	0 – 277 277 – 1260	± 2.2°C ± 0.75%	± 1.1°C ± 0.4%
J (Iron + vs. Constantan)	<ul style="list-style-type: none"> <li>» Used for reducing, inert, oxidizing or vacuum atmospheres up to 750°C</li> <li>» Not to be used in sulfurous atmospheres above 538°C</li> </ul>	0 – 277 277 – 760	± 2.2°C ± 0.75%	± 1.1°C ± 0.38%
T (Copper + vs. Constantan)	<ul style="list-style-type: none"> <li>» Corrosion resistant in moist atmospheres</li> <li>» Ideal for temperatures measurements under zero</li> <li>» Can be used in vacuum and in oxidizing, reducing or inert atmospheres up to 400°C</li> <li>» Commonly used in laboratories due to its stable and precise EMF characteristics</li> </ul>	-184 – -59 -101 – -59 -59 – 93 93 – 371	— ± 2% ± 1% ± 0.75%	± 1% ± 0.5°C ± 0.38%
E (Chromel + vs. Constantan)	<ul style="list-style-type: none"> <li>» Has the highest EMF characteristics</li> <li>» For practical applications, refer to precautions listed in type K thermocouple</li> <li>» Can be used up to 750°C continuously</li> <li>» Commonly used in large scale thermal and nuclear power plants</li> </ul>	0 – 315 315 – 871	± 1.7°C ± 0.5%	± 1°C ± 0.38%
R S	<ul style="list-style-type: none"> <li>» Available upon request</li> </ul>	0 – 538 538 – 1482	± 2.8°C ± 0.5%	± 1.4°C ± 0.25%
B	<ul style="list-style-type: none"> <li>» Available upon request</li> </ul>	871 – 1704	± 0.5%	—
N	<ul style="list-style-type: none"> <li>» Available upon request</li> </ul>	N/A	N/A	N/A

SHEATH MATERIAL			
304 STAINLESS STEEL	310 STAINLESS STEEL	316 STAINLESS STEEL	800 INCONEL®
<ul style="list-style-type: none"> <li>» General purpose</li> <li>» Economical</li> <li>» Readily available</li> <li>» Good corrosion resistant to organic and inorganic chemicals</li> <li>» Subjected to carbide precipitation in the 480°C to 870°C range</li> <li>» Maximum operating temperature: 900°C (1680°F)</li> </ul>	<ul style="list-style-type: none"> <li>» Superior to 304 stainless steel in high temperature applications</li> <li>» The best corrosion resistant sheath material to oxidation of the "300" series</li> <li>» Maximum operating temperature: 1150°C (2100°F)</li> </ul>	<ul style="list-style-type: none"> <li>» Superior corrosion resistant material than type 304 and 310 stainless steel</li> <li>» Mostly used in food processing industry</li> <li>» Ideal for sulfuric acid compounds</li> <li>» Maximum operating temperature: 900°C (1650°F)</li> </ul>	<ul style="list-style-type: none"> <li>» Composed of high nickel, high chromium content for resistance to oxidizing and reducing environments and for highly corrosive environments at high temperatures</li> <li>» Used in furnaces, chemical and food processing equipment</li> <li>» Maximum operating temperature: 1150°C (2100°F)</li> </ul>

**Note:** Other types of sheath materials are available upon request.